

**YASKAWA**

# Best in Class Products and Solutions





# Content

A Global Company 2

In Focus 4

i<sup>3</sup>-Mechatronics 4

YASKAWA Cockpit 6

Connectivity & Interoperability 8

cloudPanels, smartPanels & PanelPCs 10

Singular Control 12

Sigma-7 14

Advanced Safety for Sigma-7 16

GA500 18

MotoLogix 20

Smart Pendant 22

MotoMINI 24

MOTOMAN GP-Series 26

MOTOMAN HC10, HC10DT 28

The Switch: Turbo Applications 30

Product Overview 32

AC Drives 33

Machine Controllers 40

Control Systems 41

Servo Drives 42

Rotary Servomotors 43

Direct Drive Motors 44

Linear Motors 45

Robots 46

I/O-, Operating- and Monitoring Systems 51

Accessories- and Networking Solutions 52

# A Global Company

Yaskawa is a company of people pursuing their passion. Driven by the vision of a smarter future with advanced technologies that save precious time and energy. And for us, any given day is a new chance to make progress.

Our goal is to contribute to the evolution of society by improving the nature of its business, increasing the performance and productivity of our industry, and therefore our everyday lives. Naturally we promote renewable resources to ensure a healthy environment – for a sustainable planet for all of us.

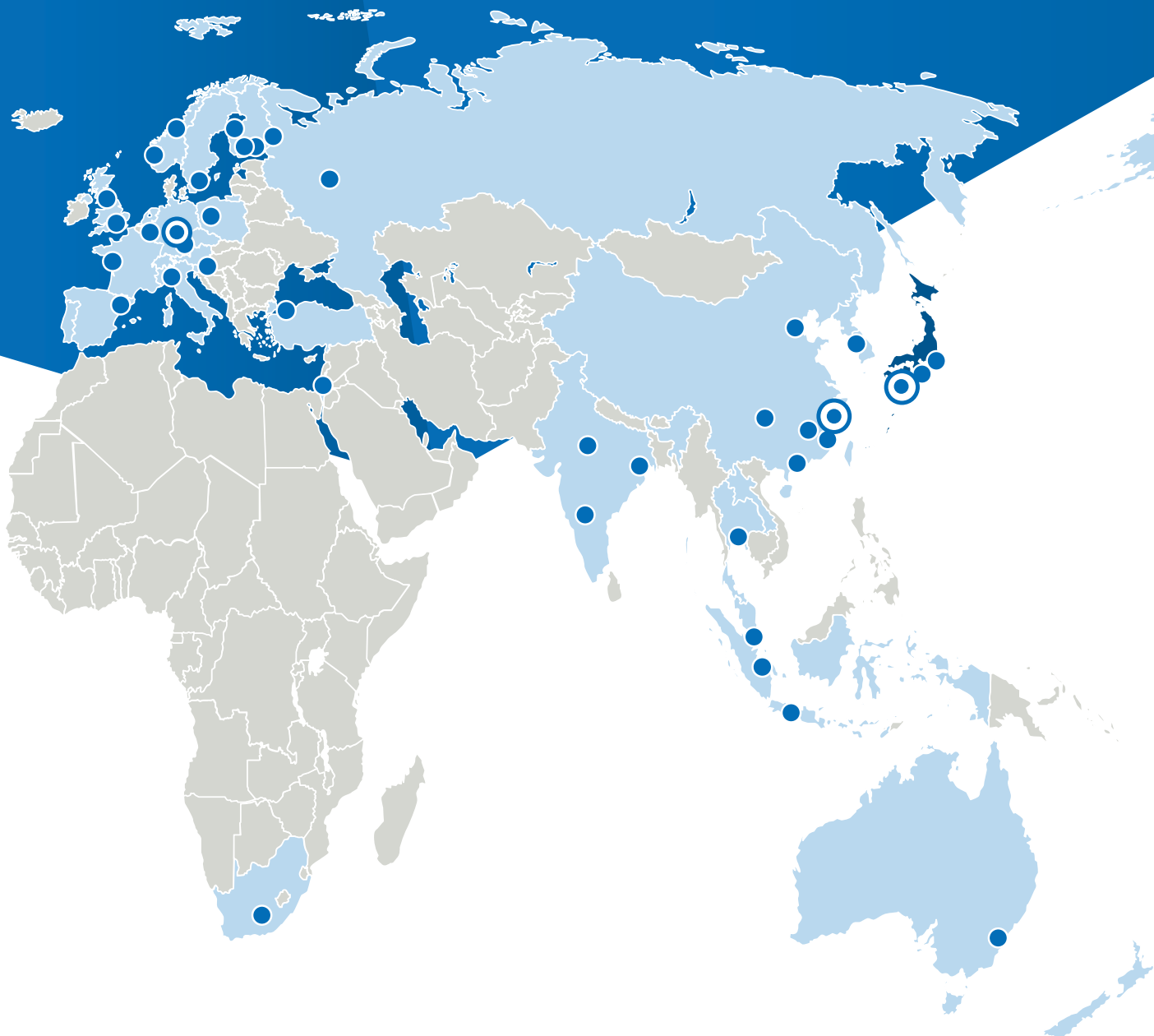



**14,500**  
Employees  
Worldwide



**1,900**  
Employees  
EMEA Region



**8**  
European  
Manufacturing Locations



**23**  
European Entities  
Regional Presence



**2.2 Million**  
AC Drives  
Production in 2018

**27 Million**  
Accumulated Units produced  
(as of 2018)



**2.1 Million**  
Servo Drives  
Production in 2018

**18 Million**  
Accumulated Units produced  
(as of 2018)



**48,000**  
Industrial Robots  
Production in 2018

**430,000**  
Accumulated Units produced  
(as of 2018)

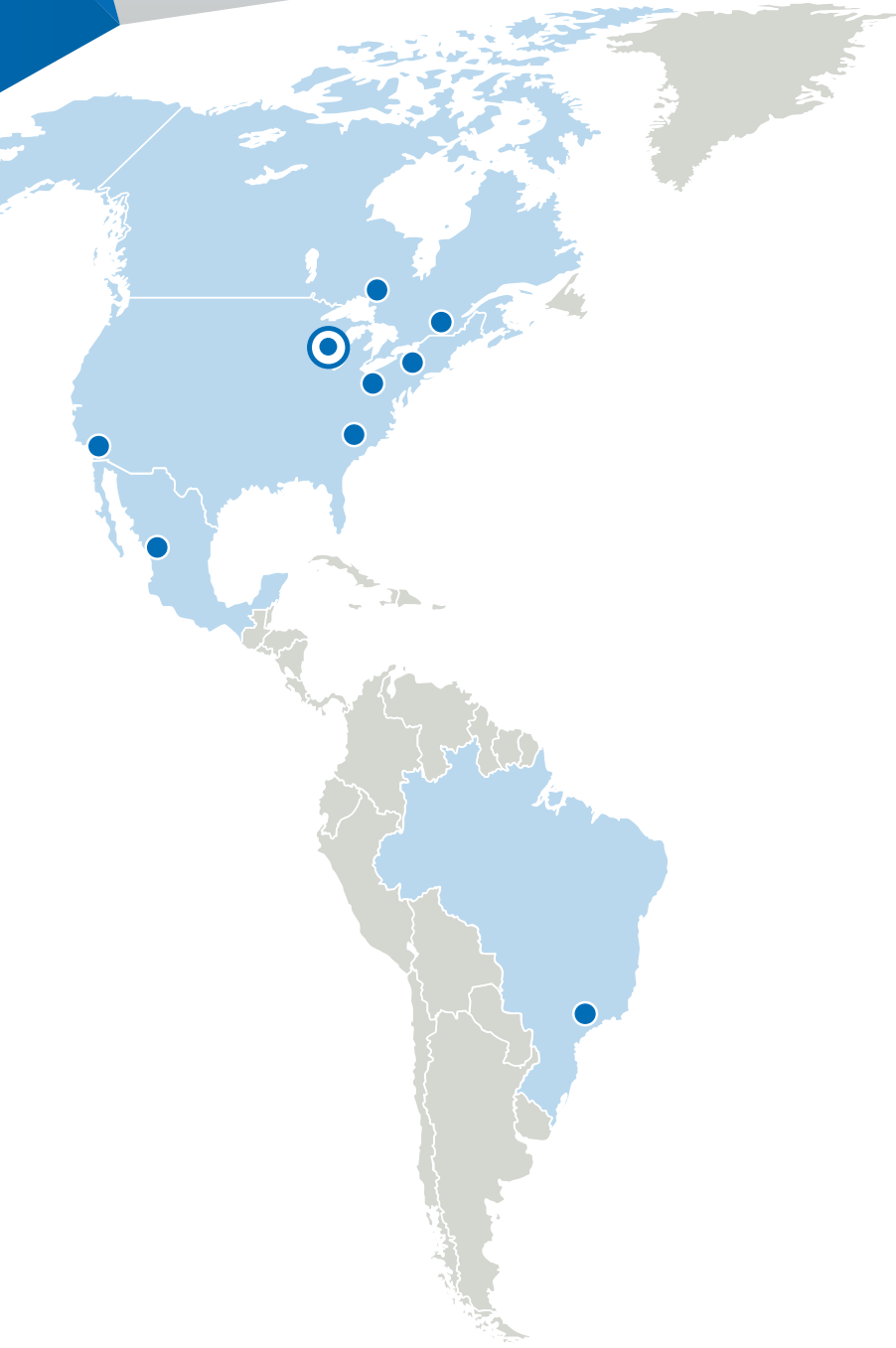

- Top 100 Global Innovator 2015, 2016, 2017, 2018<sup>\*)</sup>
- 100+ European Channel Partners
- Network of System Integrators

<sup>\*)</sup> Clarivate Analytics  
(former part of Thomson Reuters)

# i<sup>3</sup>-Mechatronics - Our Industrie 4.0 Solution

i<sup>3</sup>-Mechatronics sets our foundation for developing future factory automation, just as we did many years ago when creating the concept of Mechatronics. The connectivity and communication between all our products but also with 3rd party components and systems will enhance productivity and flexibility.

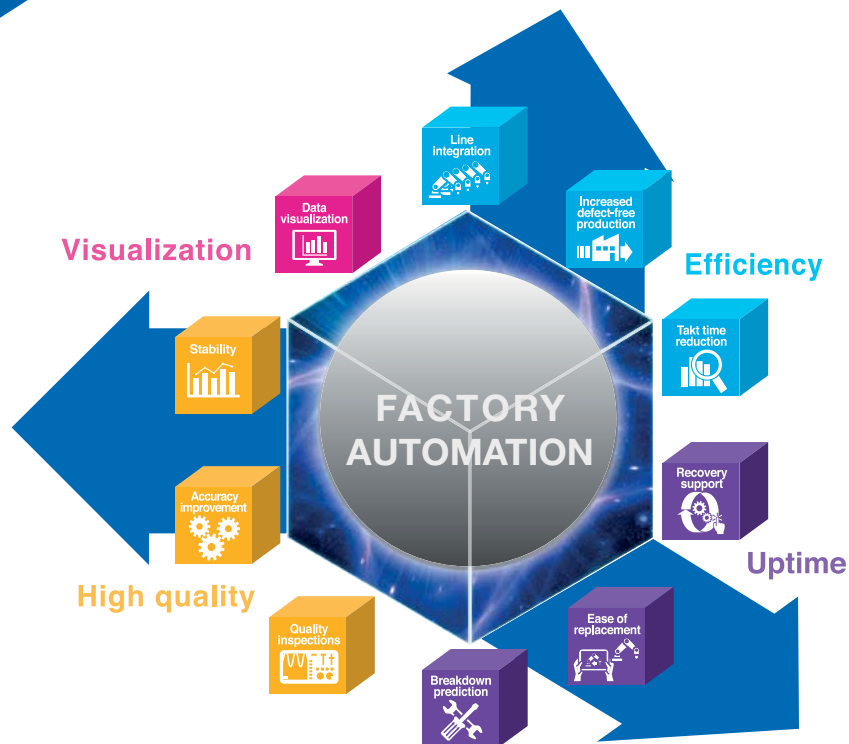

## ***i<sup>3</sup>-Mechatronics***

### **integrated**

Our production environment enables customers to collect and analyze real-time data. It is open for further data analysis with specialized Big Data tools and AI. Production data can be visualized by the YASKAWA Cockpit on application, machine and complete production line level.

### **intelligent**

Big Data analysis and AI learning of collected production site data offer new ways to optimize the production process on machine level and factory level.

### **innovative**

Insights gained from the in-depth analysis of the production process are triggering improvements and create a better level of production and quality.

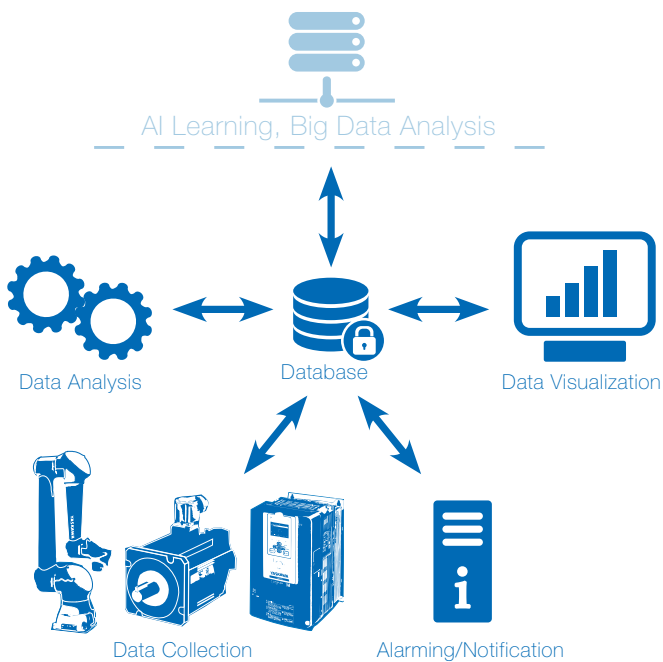

## Features

- Seamlessly integrated at edge level
- Realtime data acquisition, analysis and visualization
- Easy to use lifecycle management and predictive maintenance
- Permanent data forwarding to your pre-established ERP and MES possible
- Empowering business and planning decisions based on big data
- A complete toolbox from individual smart components to fully automated factory solutions
- Scalable solutions optimized for individual requirements
- Higher throughput, higher product quality, higher reliability, higher stability
- Supports standardized communication protocols such as OPC/UA

### Data collection

Simple and standardized data collection for Yaskawa products. API available for easy integration of 3rd party products.

### Data analysis

Gain insights of the machine and component data for predictive maintenance and increased efficiency by analyzing production KPIs, alarms and benchmarks.

### Data visualization

The gathered information can be processed and visualized on dashboards of different levels - from a complete factory view down to single devices. The dashboards are flexible and can be customized to fit customer requirements.

### AI and big data

The collection of data empowers data processing and analysis for various AI applications.

i<sup>3</sup>-Mechatronics connects smart components with live data monitoring and opens the door for sophisticated data analysis and process improvements.

# YASKAWA Cockpit

The central element of our i<sup>3</sup>-Mechatronics concept: delivering data collection, data analysis and data visualization with true added value for our customers. Depending on their needs, customers can decide whether they use the complete YASKAWA Cockpit or just individual elements.

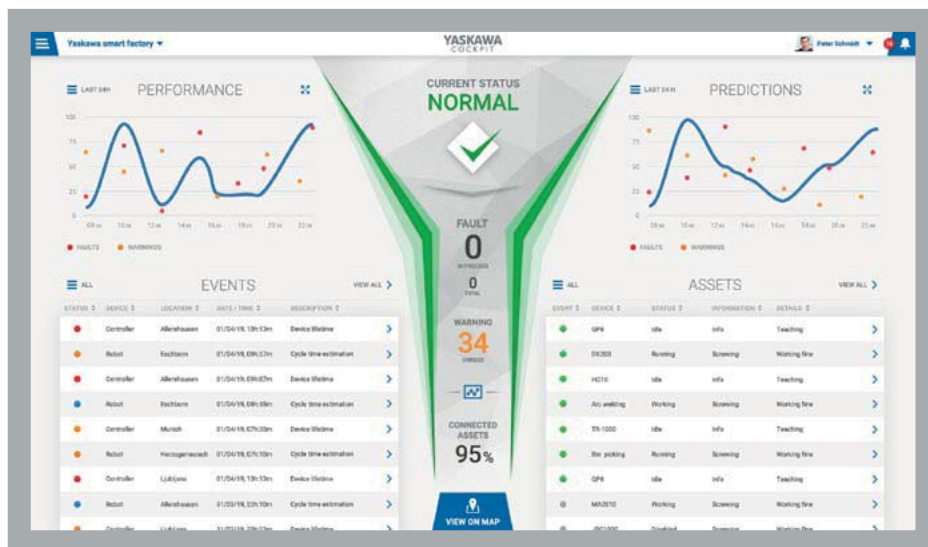

Providing customers, business partners and suppliers with factory data in real-time, allowing users at any moment to see what is happening at any point of the value creation. The generated data can be used to enhance productivity, reduce cycle times and downtime of any system and enable AI to generate knowledge for getting automation a step forward.

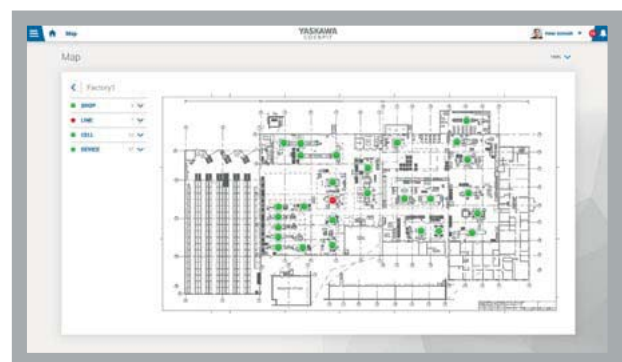

YASKAWA Cockpit provides asset management, live data monitoring and collects production data for sophisticated analysis and process improvements



## Flexible offer according to your needs

### Small end users – Out of the box solution

Data collection, analysis, notifications and visualization of asset and production data enables customers to get into full control of their machinery. The standard version of YASKAWA Cockpit offers an all in one solution.

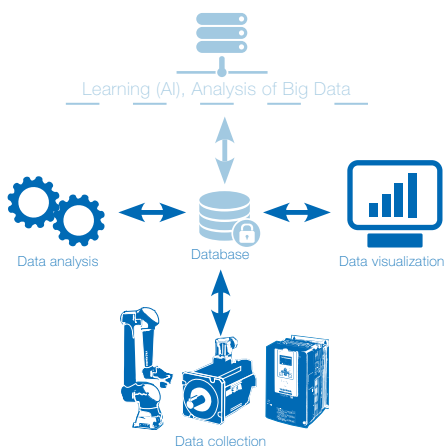
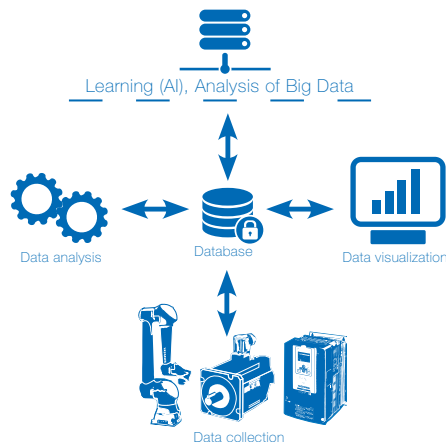

### Big end users – Selected components

Easy to implement data collection and analysis to enhance productivity and quality potentials using own data processing and visualization.

Use API data collector and API data analysis module

### System integrators – Flexible framework

With our highly customizable framework it's easy to deliver built-to-order solutions to increase efficiency and add value to customers of system integrators on top of the regular benefits of the YASKAWA Cockpit.

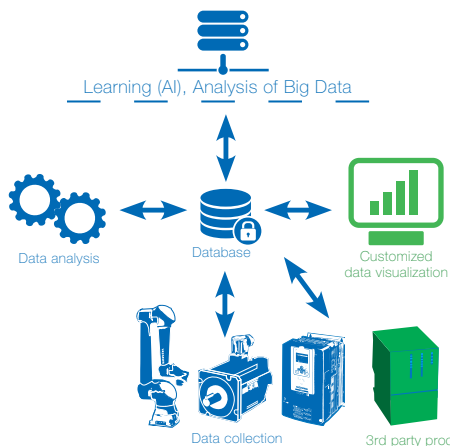

Use our Solution plus integration of 3rd party products plus customized visualization



Use API data collector and API data analysis module

### OEMs and machine builders – Fully customizable environment

OEMs and machine builders can use new analysis and visualization toolboxes tailored to their needs and process requirements. Integrate just the parts of the YASKAWA Cockpit that are most valuable to your system.



CONTROLLER



ROBOTS



HMI

**4.0**

YASKAWA COCKPIT



SERVO DRIVES

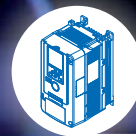

AC DRIVES

CONNECTIVITY  
ERLEBEN

# Connectivity

We speak your language

We speak many languages, in our support and service, but also with our machines and technology. Providing simple solutions to connect with EtherCAT, Ethernet/IP, PROFINET, MECHATROLINK and many more. Not sure, if Yaskawa can connect with your system? Contact us and we'll be sure to find a solution.

Open to all common fieldbus systems



Easy integration and implementation by the use of reliable function blocks

Pre-defined and tested function block library for fast implementation. Thorough documentation available. Free to use, open source for easy modification and adaptation of new features.

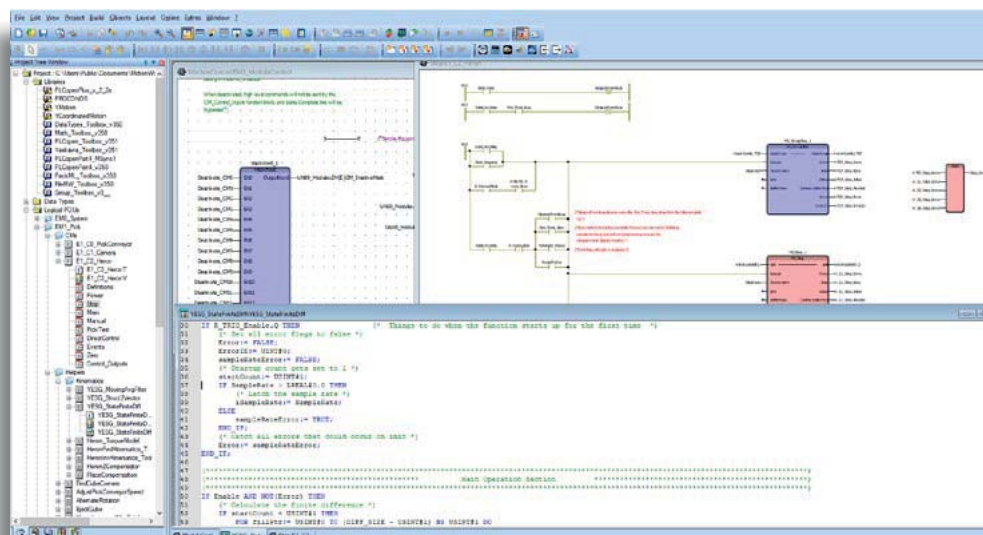

# cloudPanels, smartPanels & PanelPCs

Performance & connectivity



The right HMI for your application? No problem with our cloudPanels, smartPanels & PanelPCs. Our panel series have been designed to address current and future developments in the visualization market. In the process, we consciously focused on emerging technologies like cloud, WebVisu and the likes.

#### cloudPanel

The cloudPanels are optimized for web applications and therefore the perfect companion for WebVisu projects. Since the feature for creating a WebVisu is already integrated in the SPEED7 Studio engineering tool, visualization via the cloudPanel is child's play: it runs within the respective PLC and is called up by the cloudPanel via an HTML5-capable web browser. This visualization option represents a cost-effective solution, especially for smaller applications.

#### smartPanel

The smartPanels are optimally designed for small to medium-sized applications. They provide excellent usability and connectivity. Equipped with Movicon 11 Standard, there are practically no restrictions imposed on the user in terms of tags, screens, recipes, alarms, etc.

#### PanelPC

With the PanelPC series, you are ideally equipped for all control and monitoring tasks. The combination of an industrial PC with state-of-the-art performance features and a touch panel with optimized display options concentrates high performance in the smallest space. The necessary performance is provided by an Intel Celeron quad core processor, optionally with Windows Standard 7 or Windows Compact 7 as operating system and Movicon 11.5 Runtime and Editor for the visualization application.

### cloudPanels

- Display: 4.3" / 7" / 10.1
- CPU: Cortex-A8 1GHz
- RAM: 512MB
- Storage memory: 4GB
- Interface onboard: 1x RS232/422/485, 1x USB-A, 1x RJ45 (Ethernet)
- Software: Linux 3.12

### smartPanel TP307-SM

- Display: 4.3" / 7" / 10.1"
- CPU: Cortex-A8 1GHz
- RAM: 512MB
- Storage memory: 4GB
- Interface onboard: 1x RS232/422/485, 1x USB-A, 1x RJ45 (Ethernet)
- Software: Windows Embedded Compact 7, Movicon CE Standard

### PanelPC

- Display: 10.1" / 15.6" / 21.5"
- CPU: Intel Celeron J1900 quad core 2GHz
- RAM: 4GB
- Operating system and storage memory: up to 16GB (depending on the model)
- Memory card slot: CFast
- Interfaces: 2x RJ45 (Ethernet) (10/100/1000), 2x USB 2.0, 1x USB 3.0, 2x serial (RS232, RS422/RS485), Audio out
- Operating system: Windows Embedded Standard 7 or Windows Compact 7
- Software: Movicon Runtime and Editor

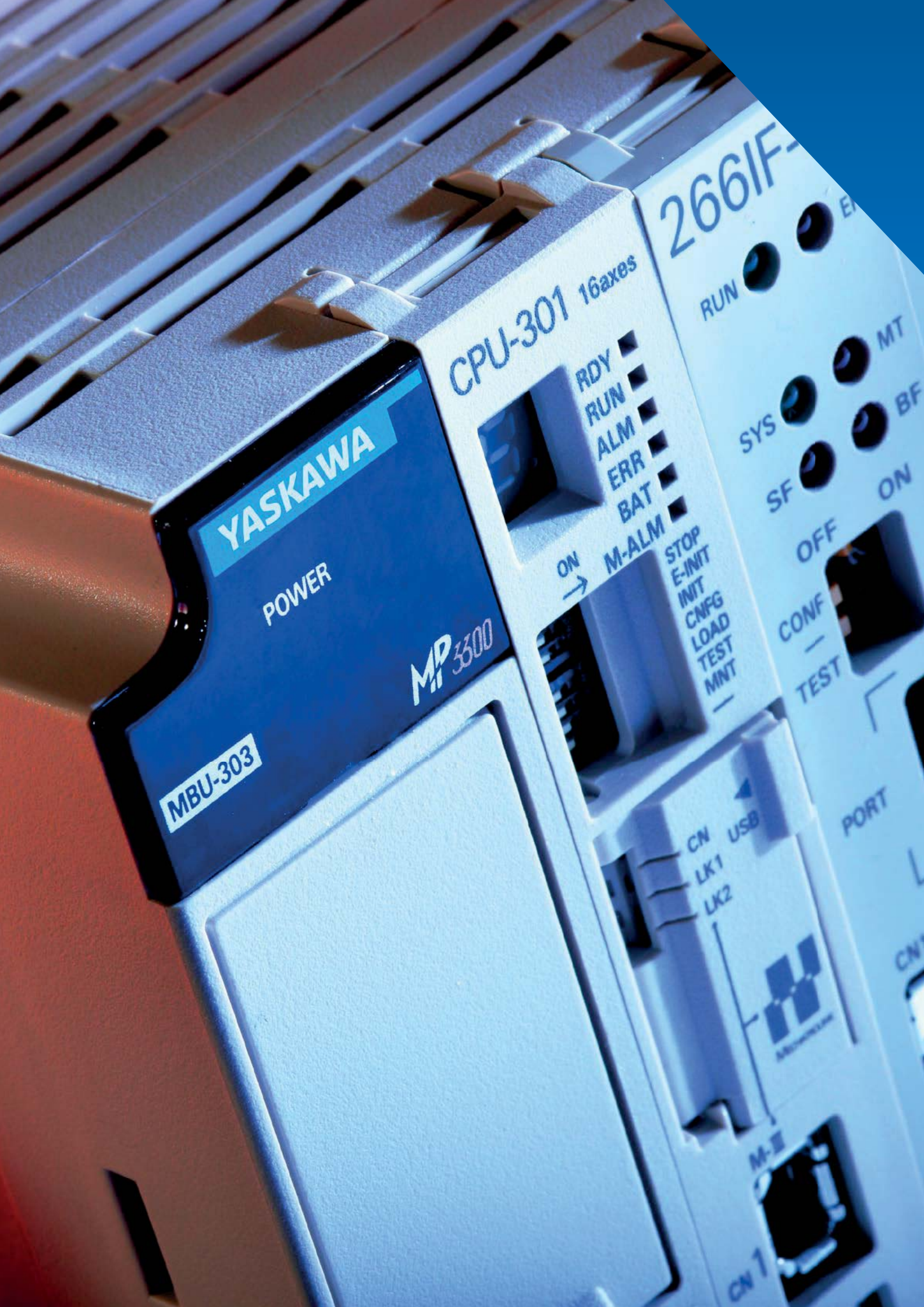

YASKAWA

POWER

MP II 3300

MBU-303

CPU-301 16axes

RDY  
RUN  
ALM  
ERR  
BAT  
M-ALM

ON  
→

266IF-

RUN

SYS

SF

OFF

CONF

TEST

PORT

CN USB

LK1

LK2

M-E

CN 1

# Singular Control

One software. One controller. For everything in motion.

If you're familiar with standard ladder logic and function block programming, you can already program every component in a complete automation system, including robots and servo systems.

## ONE SOFTWARE ONE CONTROLLER

### What is Singular Control?

Motion, Robots, VFD's, and I/O on a single controller programmed in a single software environment.

The heart of the solution is the MP3300iec controller, where all of the application programming is performed in one software environment (MotionWorks IEC) using structured text, sequential function chart (SFC), industry-standard PLCopen function blocks and ladder logic, and includes vision integration and conveyor tracking.

The magic of Singular control: regardless of the mechanism, the function blocks used for motion programming are the same. This allows you to implement robotics with standard motion control without the need for a programming pendant or a proprietary robotic programming language. If your machine includes standard motion axes, robotics, or special mechanisms, the entire system can be programmed in one software environment. You can upgrade your machines with new mechanisms (to add flexibility or throughput) without the need to change the application program or introduce new controllers into the system.

### Features

- One for all:  
Robots, Servo systems, Logic control
- Up to 62 axes + 2 virtual axes of motion
- Built-in web server lets you check status or run diagnostics through a standard web browser
- Networking options:  
Modbus TCP, EtherNet/IP, Mechatrolink III and OPC
- Easy interface with HMI and I/O solutions
- Manage every system component with one software package, running on one motion controller.
- Migrate a motion application from servos to robots and back again, without changing application code.
- Do it all with the IEC 61131-3 programming your team already knows and is comfortable using.



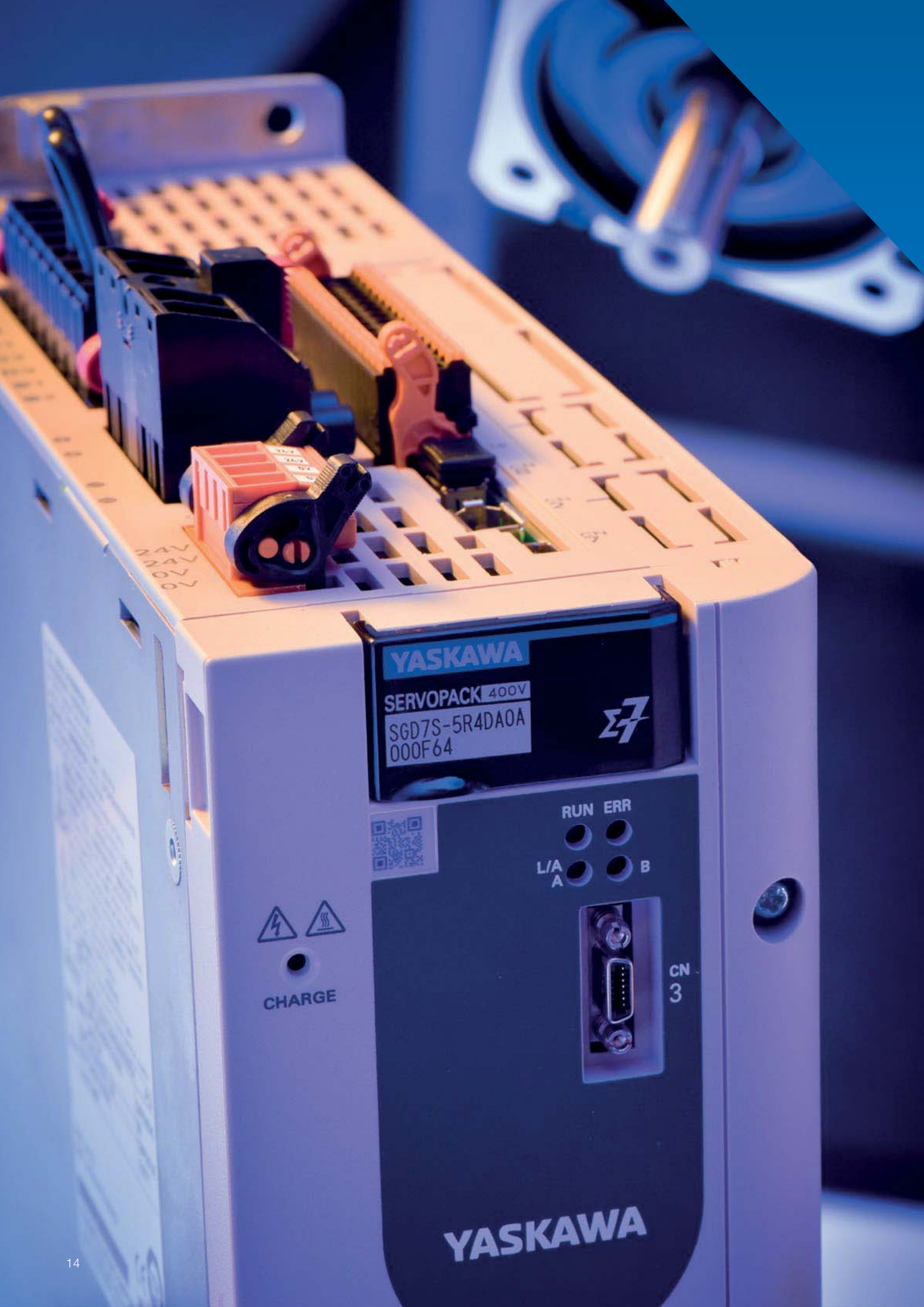

**YASKAWA**

**SERVOPACK 400V**

SGD7S-5R4DA0A  
000F64



RUN ERR

L/A

B



CHARGE



CN  
3

**YASKAWA**



# Sigma-7

Quick, fast, reliable

Servo drives of the Sigma-7 series stand out due to their uncompromising performance. From consistently simple and fast commissioning in just 3 minutes to maximized machine throughput.

25 years of experience and several million installed servo drives are the basis for these outstanding servo systems. The Sigma-7 series, which is available in 200V and 400V versions, provides performance that can hardly be found in other servo systems and delivers real benefits in terms of cost and time savings:

### Tuning less mode

The Tuning less mode allows many applications to use the drives right out of the box without further adjustments or tuning. In this way the sophisticated algorithms help to save commissioning time.

### Automatic load adjustment

Automatic load adjustment adapts the control loop up to an inertia ratio of 30:1. This means one type of motor can be used in different applications. This reduces inventory diversification, saves stocking and minimizes procurement costs.

### Advanced auto-tuning

Advanced Auto-tuning reduces settling time to up to 4 ms in most applications and therefore optimizes machine productivity.

### Advanced functions

Functions like vibration suppression, power ripple and friction compensation reduce engineering efforts and help getting the most out of a machine with minimized efforts and at lowest cost.

Function	200V	400V
Power range	50 W – 15 kW	200 W – 15 kW
Encoder	24 bit absolute	
Protection class	IP67 by default	
Single axis	✓	✓
Dual axis	✓	✓
Rotary motors	One amplifier for all	One amplifier for all
Linear motors		
Direct drive motors		–
Integrated motion controller	✓	✓

EtherCAT®

PROFI®  
NET

MECHATROLINK



Sigma-7 200V



Sigma-7 400V

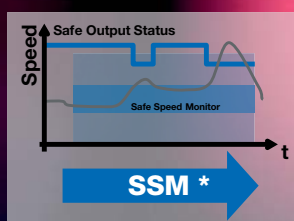
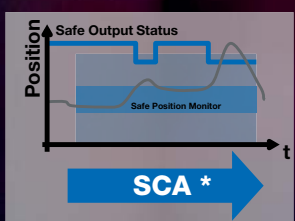
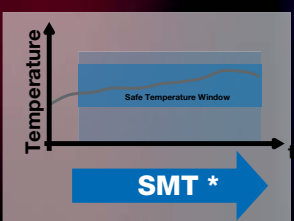
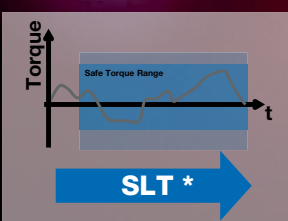
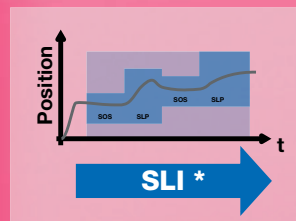
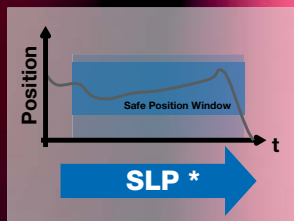
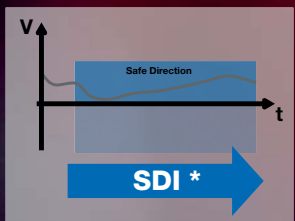
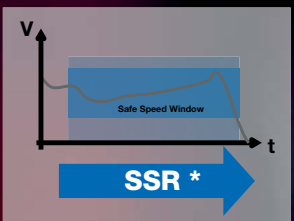
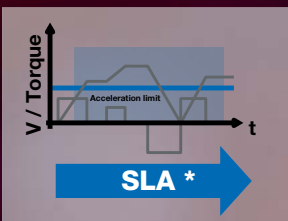
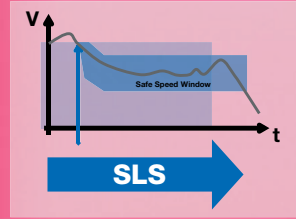
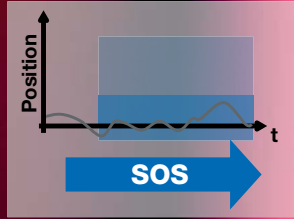
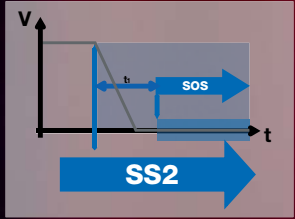
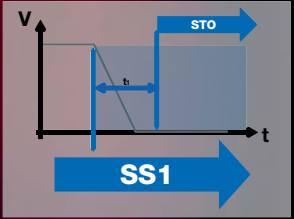
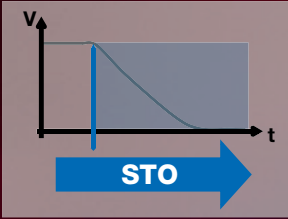

**FSoE  
(FailSafe over  
EtherCAT)**

# Advanced Safety for Sigma-7

Open & scalable according to your needs

Yaskawa offers a new generation of safety modules, which are geared to your requirements. They follow with SIL3/PLe and FSoE (FailSafe over EtherCAT) the latest standards of the industry.

In order to find a suitable and economical solution for your application Yaskawa offers a scalable concept. While Safe Torque Off is integrated in every SERVOPACK, three different option modules can be selected for further requirements:

Option Module	Safety Functions	I/Os	FSoE
SGDV-OSA01A	STO/SS1/SS2/SOS/SLS	<ul style="list-style-type: none"> <li>• 2 Safe Inputs</li> </ul>	-
SGD7S-OSB02A*	STO/SS1/SS2/SOS/SLS/SLA/SSR/SDI/SLP/SLI/SLT/SMT/SCA/SSM	-	✓
SGD7S-OSB01A*	STO/SS1/SS2/SOS/SLS/SLA/SSR/SDI/SLP/SLI/SLT/SMT/SCA/SSM	<ul style="list-style-type: none"> <li>• 4 Safe I/Os</li> <li>• 2 Safe Inputs</li> <li>• 1 Safe Analogue Input</li> <li>• 1 Input 4 - 20 mA</li> <li>• 1 Input PT100 / PT1000</li> </ul>	✓

The 14 safety functions enable you to find a suitable solution for many applications. Fulfilling for every safety function the latest standard SIL3/ PLe (Cat. 3) Yaskawa supports you to easily reduce risks.

The new generation of safety modules from Yaskawa is also providing FSoE Slave functionality. Combining Safety and the open as well as common Ethernet based fieldbus system EtherCAT helps you to realize your safety application with less effort for wiring.

## Key Features

- STO (Safe Torque Off) integrated
- 3 different option modules provide a scalable approach for your requirements
- 14 safety functions allow for a lot of applications a suitable solution
- All safety functions fulfil SIL3/PLe (Cat. 3)
- 6 configurable Safe I/O Channels
- 1 Safe Analogue Input Channel
- Via FSoE (FailSafe over EtherCAT) the safety functions can be controlled and monitored via fieldbus



# GA500

Balancing power to perfection

Cost-saving by optimized application  
Efficiency

Experience from 23 million  
installed AC drives

Application Reliability by 10 years of  
maintenance free drive operation

Flexibility to master any challenge

Maximize machine Performance

Ease of use minimizes setup times



More than 100 years of experience with driving electric motors have led Yaskawa to develop products which perfectly combine technical superiority with easy handling. The latest result of this evolution is the new GA500 micro-drive. Compact in size and flexible in terms of motor type and connectivity, the GA500 is designed to easily master nearly any application.

### Simplify system integration

GA500 drives are designed to be easily integrated into systems and machinery. Combining network support, application focused features and great customizability with unparalleled ease of use, the GA500 minimizes efforts to get your automation jobs done.

### Fast installation and setup

GA500 drives embed various features eliminating the need for peripherals. This in line with easy wiring plus smart functions for doing a basic setup literally in 5 minutes greatly reduce the time and cost required to having a running system.

### Best machine performance

By integrating latest motor control technology for induction, permanent magnet and synchronous reluctance motors, the GA500 drives provide best control performance at minimized energy consumption.

### Operation secured

GA500 drives are built to perform reliably. The robust design with coated PCBs allows operation in 50 °C without derating while machine monitoring functions and an integrated life time prediction prevent sudden failures. Thus GA500 effectively secures operation and prevents production loss.

## Features

- Easy network integration
- Robust design. Can be operated in up to 4000 m altitude and 60 °C hot environment
- Coated PCBs
- Embedded braking chopper
- Integrierte Programmierumgebung
- 24 VDC Power Input for Controller
- USB port
- 10 years maintenance-free design
- Screwless Control Terminals
- Easily Accessible Mains Terminals
- 24 VDC Power for Sensors
- Built-in EMC Filter
- One drive for various applications (induction, permanent magnet and synchronous reluctance motors)



Search for

**YASKAWA**

on



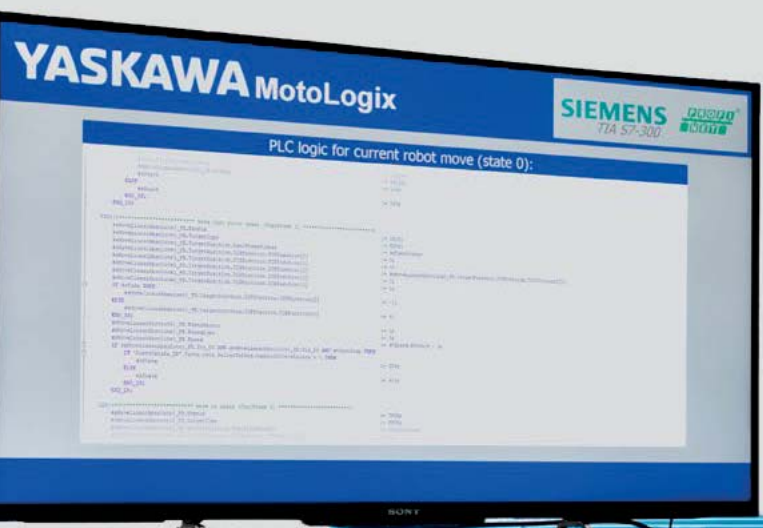

# MotoLogix

Interface for MOTOMAN robot programming and control via PLC

MotoLogix is a software interface for programming and control of Yaskawa robots by PLC. Being available for all major PLC brands and fieldbuses it is designed with two primary objectives:

- Enable deep integration of Yaskawa robot systems in PLC controlled machinery.
- Easy programming/commissioning/teaching/operating of robots in a machine, without need of specialized knowledge.

## MotoLogix has two components

### 1. MotoLogix Runtime

Enables the MotoLogix interface on the Yaskawa robot controller, using the fieldbus for communication with the PLC.

### 2. MotoLogix PLC Library + Examples

Comprehensive set of function blocks for writing the robot application logic in the PLC (example programs).

## Features

- Robot programming carried out in PLC language – unified for the whole system
- Connects all peripheral devices (sensor, camera, conveyor) through PLC
- Robot completely integrated in the PLC and HMI environment
- Testing of the complete PLC/HMI robot application using virtualization (MotoSim)
- Assurance of a Yaskawa path accuracy (calculation in MOTOMAN controller)
- All Yaskawa DX200, YRC1000 and YRC-1000micro robots can be controlled. This includes the collaborative types such as HC10
- No Teach pendant nor Yaskawa robotics knowledge is required for robot programming and operation
- Data stored in the PLC, not in the robot controller
- Control up to 4 robots over one MotoLogix interface
- MotoLogix on a OPC-UA equipped PLC can act as a convenient gateway to PC based systems such as LabView

## Supported Platforms:

YASKAWA  
PROFINET

B&R  
POWERLINK

SIEMENS  
TIA S7-300  
PROFINET

Rockwell  
EtherNet/IP

SIEMENS  
TIA S7-1500  
PROFINET

CODESYS  
EtherCAT

SIEMENS  
SIMOTION  
PROFINET

CODESYS  
EtherNet/IP

Beckhoff  
EtherCAT

CODESYS  
PROFINET

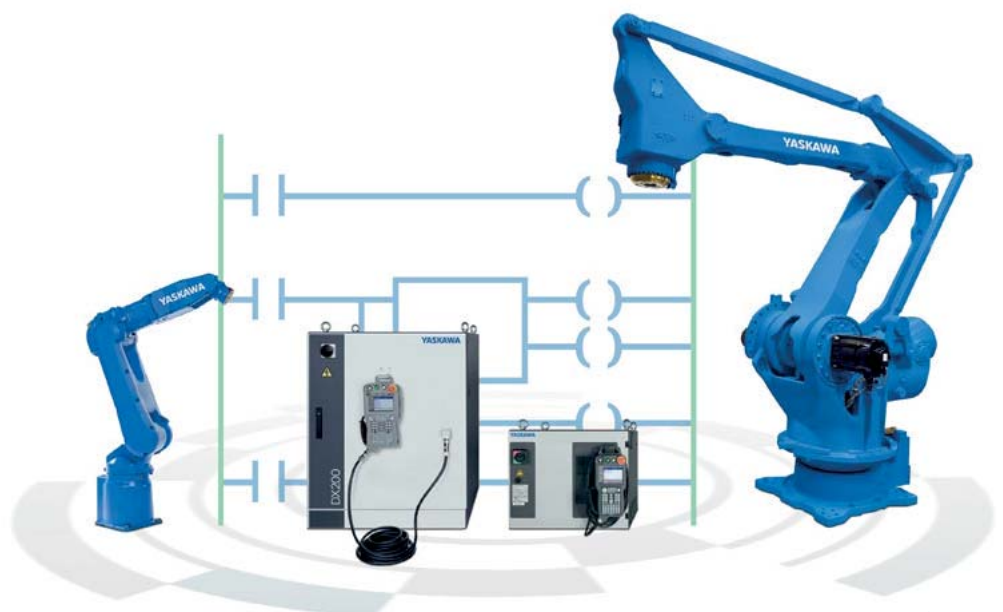

# Smart Pendant

Next generation robot control interface

Smart Pendant reduces what the user needs to remember in order to enter instructions and values, and the procedures for doing so. The main menu makes switching between screens more user-friendly, as all menus are listed in a sequence that requires minimal memorization. Easy access to all functions: The user can remember the location of each item in the navigation menu and safely return to the home menu in case of confusion.







### Smart Pendant and SMART FRAME

Smart Pendant introduces a new type of coordinate frame: SMART FRAME. Traditional teach pendant programming requires the operator to select the appropriate coordinate frame (joint, world, tool or user), which defines the direction in which the robot will move when a button is pressed. If the frame is not set correctly, moving the robot in the wrong direction or with the wrong trajectory can lead to problems and require time-consuming corrections.

Hand Guiding is a collaborative feature that allows an operator to hand-guide the robot to a desired position. This task can be achieved by utilizing additional external hardware mounted directly on the robot or by a robot specifically designed to support this feature, e.g. HC10.

Smart Pendant is Yaskawa's next generation programming pendant that makes no compromise between ease of use and capability.

### Features

- Easy-to-understand operation and user interface designed with customer participation
- Simplified INFORM programming without loss of functionality
- Command Builder for automatic INFORM generation
- SMART FRAME jogging eliminates coordinate frames
- Direct teaching with hand guiding for HC10
- Built in Help function and "How-To" guides



# MotoMINI

Small. Lightweight. Fast.

The MotoMINI 6-axis robot was especially designed for handling and assembly of small work pieces. It reduces the size of your production line and helps to increase productivity.

This light weight high-speed robot provides a payload of 500g and a maximum reach of 350 mm. The high repeatability of 0.02mm offers superior performance in small part handling and assembly. It is easy to change the location of MotoMINI according to the line's operating condition or the work piece being manufactured.

This robot is driven by the also small and compact MOTOMAN YRC1000micro controller, which is especially suited to operate small robots.

## Key Benefits

- Small and fast
- Lightweight and portable
- Superior performance in small part handling & assembly
- Minimum footprint
- Flexible positioning

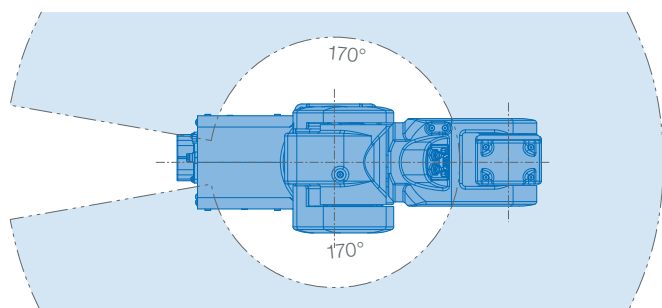
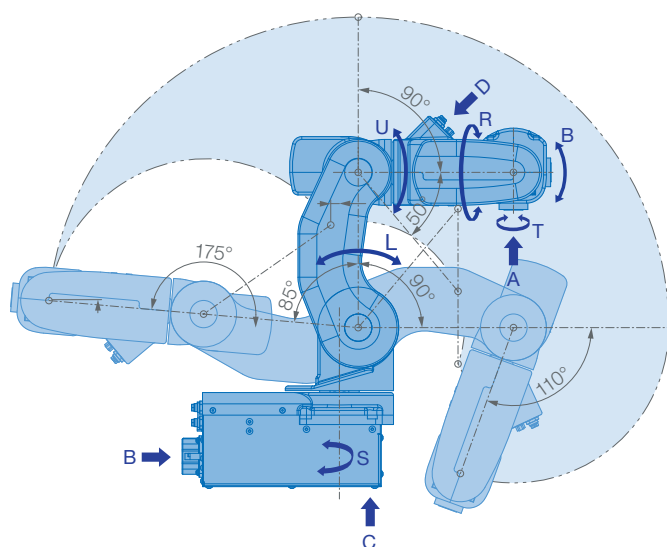



MOTOMAN GP8



red dot award 2018  
winner



# MOTOMAN GP-Series

Handling & general application

Yaskawa completes its range of MOTOMAN industrial robots and now offers models for handling and general applications from 7 to 600kg. A total of 17 models, most of which are IP67 rated, can all be programmed and controlled with the new and smaller YRC1000 controller. With numerous special application functions that are already implemented in the controller, automation tasks can be implemented with ease.

The slim and curvy design allows the manipulator to dive deep into work areas, while the smooth surfaces make cleaning the GP robots easier. Only one robot cable is required for the connection between the manipulator and the controller. The advantages of this solution are reduced wear and reduced space requirements, as well as reduced maintenance costs and smaller required spare parts stock.

The robots of the GP series are controlled by the new MOTOMAN YRC1000 control unit. The new drive technology reduces the time required for the actuation process with the aid of minimized movement changes due to different speeds. This extremely compact controller allows for optimal space utilization and is designed to set new standards with robot acceleration and speed.

The YRC1000 controller programmer provides improved cable routing. With only 730g, it is the lightest programming device in its category and can confirm robot positions via the 3D robot model display. The touch screen allows intuitive operation and thus easy movement and scrolling with the cursor.

## Highlights

- Increase productivity:  
A variety of workpieces can be transferred and different grippers can be mounted
- Make equipment compact:  
Slim and easy-to-use structure
- Easy set-up
- Robot surface is designed to prevent adherence of dust
- High environmental performance:  
Its structure can resist dust and coolants due to its IP67 standard protection class
- Easy maintenance:  
Data saving feature enables to replace the wire harness in the robot without having to connect to a battery
- Productivity improvement due to reduction in number of cables & connectors

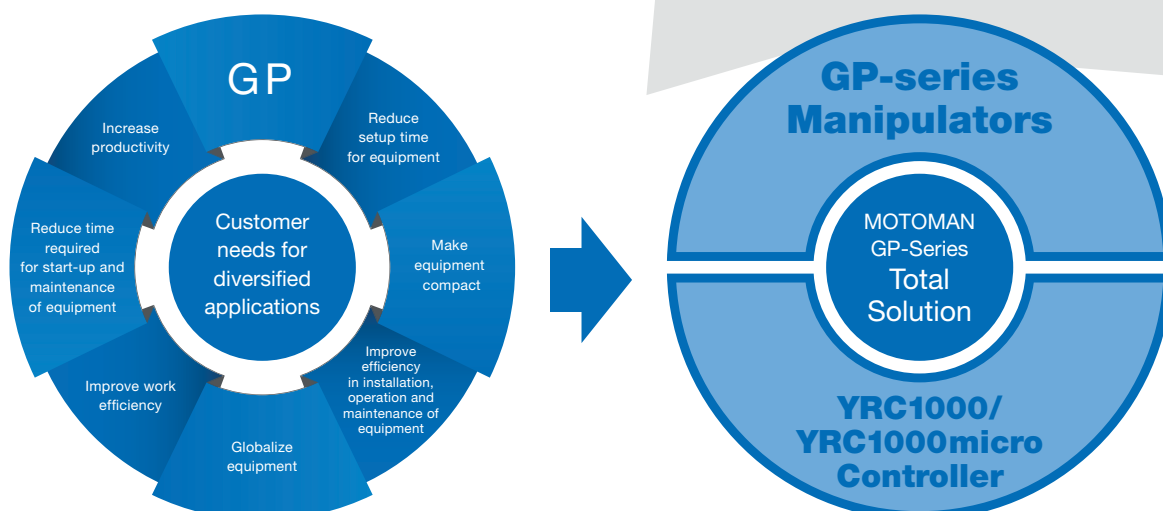



# MOTOMAN HC10, HC10DT

Human-Collaborative Robots

MOTOMAN HC10 is a 6 axes human-collaborative robot with a payload of 10 kg. Operator's safety is assured by a Power and Force Limit technology that stops the robot in case of contact with an operator.

The robot arm can be hand guided by an operator and robot positions and gripper operation can be registered via so called „Easy Teaching Smart HUB“. These features offer time saving during the robot programming. The robots arm geometry was designed to avoid pinch points (finger).

The MOTOMAN HC10 can operate without additional protective measures like a safety fence, depending on the risk assessment. This saves space and costs. Its installation area is very flexible and therefore able to operate at different workplaces.

Controlled by  
**YRC1000**

Controlled by  
**YRC1000  
micro**



## Highlights

### Controller

- Fully industrial robot controller
  - YRC1000 for HC10 and HC10DT
  - YRC1000micro for HC10DT

### High safety

- Contact force between operator and robot is limited to a safe level
- Arm geometry designed to avoid pinch points (finger protection)
- Safety standards – applications for Industrial robots:
  - ISO 10218-1 (5.10.5 Power and Force limiting)
- Complies to ISO TS 15066
- Safety functions industrial robot controller:
  - ISO 13849-1, PLd, Cat. 3
- Functional Safety Unit included

### Easy teaching

- Move the robot arm directly via hand guiding function: easy teaching mode with a switch box

### No safety fence

- Depending on the application, the HC10 can be used without a safety fence

# Motors and Drives for Turbo Applications

Up to 15,000 rpm

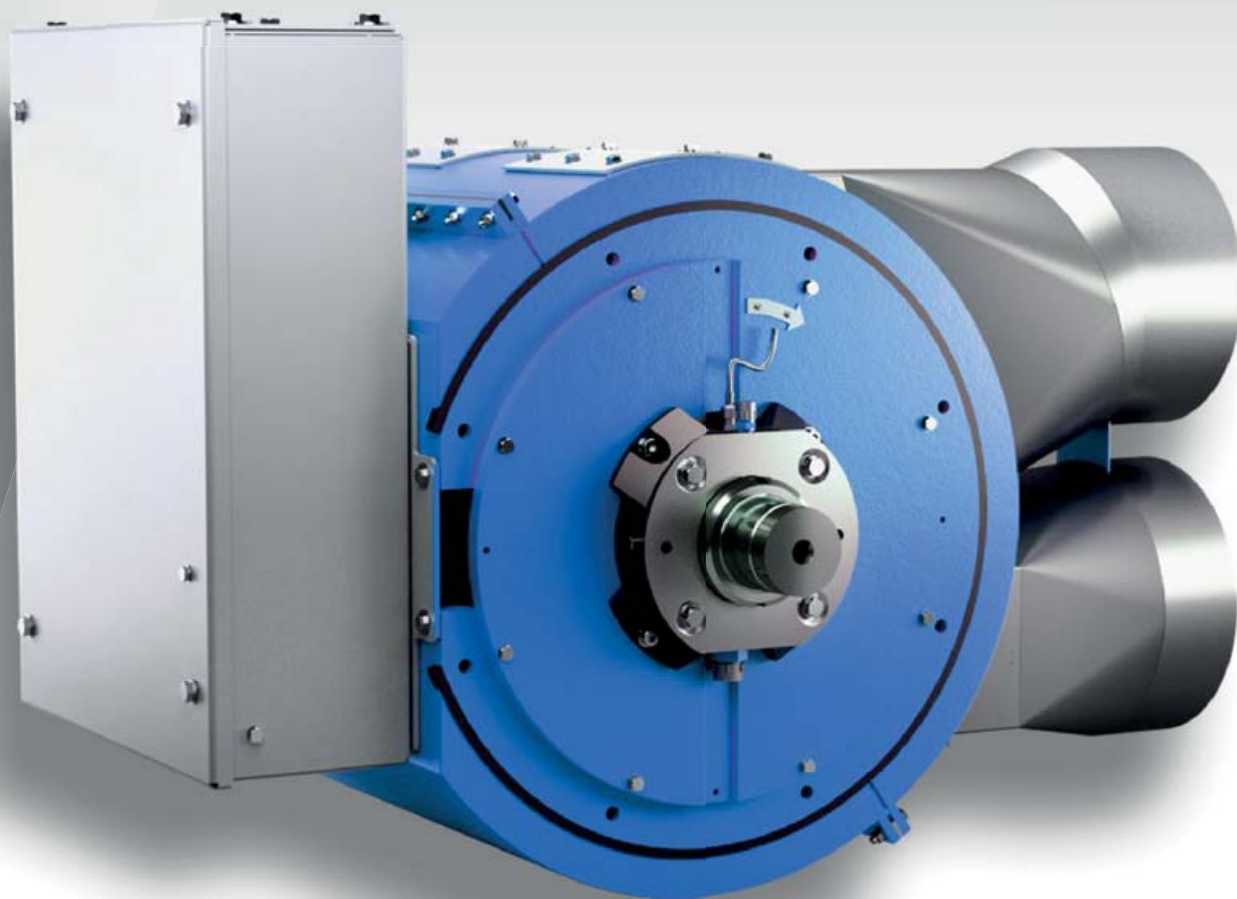



The demand for direct-drive variable speed systems is growing because they do not require reduction or multiplier gears, which are indispensable in conventional electric motor drive systems. Direct-drive variable speed systems allow you to go gearless, giving you significant savings in maintenance and space. Plus, their full speed control over the entire operating range helps you reach unmatched levels of energy efficiency.

### Run gearlessly and efficiently higher than 3,000 or 3,600 rpm

A solid rotor induction motor is a unique type of induction machine with a non-laminated rotor construction. The advantage of the stiff construction is unmatched stability and balance, offering exceptional rotating system reliability for all types of turbo applications.

The Switch turbo electrical induction motors eliminate the mechanical gearbox to give you full speed control for your system. By integrating an electrical motor with the load machinery, you get unrivaled space and weight savings.

Even better, this solution offers high energy efficiency and savings.

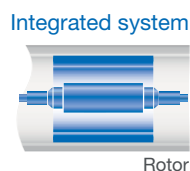
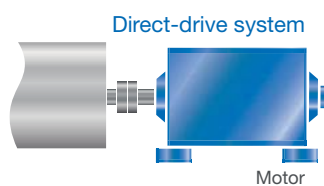
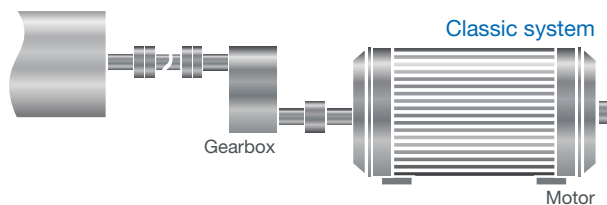

A direct-drive or integrated system is simpler and more cost efficient since the gearbox is eliminated.

### Advantages

- High efficiency
- Compact and lightweight design
- Advanced rotor and stator technology
- High availability and reduced maintenance need
- Exceptional reliability

### Turbo Drive Package

- Delivery scope: only active parts or full motor, variable speed drive and lubrication unit
- Up to 15,000 rpm with standard bearings; higher speeds on request
- Bearing selection: roller bearings, journal bearings, magnetic bearings
- Standard shaft heights: 315, 355 or 400; 250 on request
- Drives: 400/480 V and 600/690 V, liquid- or air-cooled
- Both motor and drive up to multiple megawatts

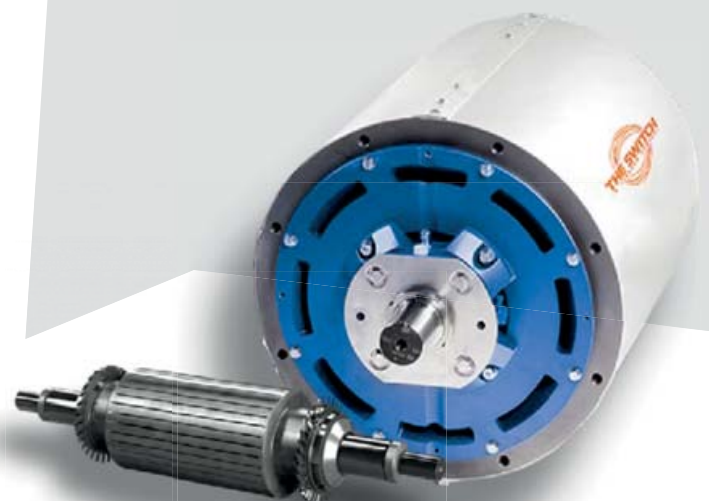

# Product Overview

## GA700

Sustainable, Flexible, Easy  
Standard AC Drive

The GA700 precisely controls induction, permanent magnet, and synchronous reluctance motors providing versatility to run a variety of applications with just one drive. The times of complex motor set-up are over. With the new EZ vector mode, the GA700 can run all of these motor types without comprehensive tuning.

Technical Data	GA700
Motor power range [kW]	0.55–355
Induction motor (IM)	√
Permanent magnet motor (PM)	√
Synchronous reluctance motor	√

### Features

- Easy set-up due to the integrated start-up wizard
- Integrated features (STO with SIL3, Braking transistor [up to 75 kW], EMC filter, DC reactor [22 kW and above] ...)
- Data logging with real time stamp up to 32 GB on Micro SD card
- Mobile Device Connectivity: Cloud connected DriveWizard Mobile App for drive management on smartphones and tablets, Manual App providing technical documentation exactly where you need it
- Safe programming when switched off
- Network up to five GA700 drives with a single communication card

### Easy programming

DriveWorksEZ® is the intuitive graphical programming environment for the GA700. Create customized functions for your application in shortest time by drag and drop function blocks. The online diagnosis tool supports testing.





## GA500

### Microdrives for Industrial Applications Standard AC Drives

Compact in size and flexible in terms of motor type and connectivity, the GA500 is designed to easily master nearly any application.

### Features

- Easy network integration
- Robust design. Can be operated in up to 4000 m altitude and 60 °C hot environment
- Coated PCBs
- Embedded braking chopper
- Integrierte Programmierumgebung
- 24 VDC Power Input for Controller
- USB port
- 10 years maintenance-free design
- Screwless Control Terminals
- Easily Accessible Mains Terminals
- 24 VDC Power for Sensors
- Built-in EMC Filter
- One drive for various applications (induction, permanent magnet and synchronous reluctance motors)

Technical Data	GA500
Motor power range [kW]	0.1 – 30
Induction motor (IM)	√
Permanent magnet motor (PM)	√
Synchronous reluctance motor	√



## A1000

### Multi-Purpose, High Performance Inverter Drive Standard AC Drives

The inverter drives of the A1000 series are extremely robust and versatile. They show their strong points especially in applications like extruders, cranes and hoists, HVAC, compressors and conveyors. The DNV/GL certification approves the use of A1000 drives under very tough conditions, like marine and offshore.

Technical Data	A1000
Motor power range [kW]	0.55 – 630
Induction motor (IM)	√
Permanent magnet motor (PM)	√



### Features

- Open- and closed-loop-control for induction and permanent magnet motors
- Suitable for plenty of applications
- Perform PLC tasks directly on the drive
- Available as IP54 Wall Mount or IP54 Ready drive as well as customized IP23/54 Floor Standing panel
- Solutions for positioning and highspeed applications, winder, electronic line shaft, cranes





## V1000

Compact and flexible  
Standard AC Drives

The V1000 is a compact inverter drive suitable for operating induction motors and permanent magnet motors (PM). Due to various fieldbus connections and built-in functions such as brake chopper, PID control, power failure bridging, flying start, it is optimally suited for the energy-efficient drive of applications like hoists, extruders, HVAC, fans, pumps, compressors, conveyors or washing machines.

### Features

- Open-loop-control for induction and permanent magnet motors
- Suitable for plenty of applications
- Designed for 10 years maintenance free operation
- Also available in IP66 and fanless
- 150% overload for 60 sec for heavy duty applications
- Functional Safety integrated (STO, SIL2, PL-d)
- Easy integration of PLC functionality with DriveWorksEZ engineering platform

Technical Data	V1000
Motor power range [kW]	0.1 – 18.5
Induction motor (IM)	✓
Permanent magnet motor (PM)	✓

## J1000

The Compact Inverter  
Standard AC Drives

The J1000 is a compact inverter drive for use with induction motors. It can be put into operation very quickly and easily. The drive is particularly suitable for applications such as fans, pumps, conveyor belts or similar.



Technical Data	J1000
Motor power range [kW]	0.1 – 5.5
Induction motor (IM)	✓

### Features

- Extremely small size
- Only some settings required for quick set-up
- For Single-phase & Three-phase main power supply connection
- Dual rating (ND/HD) for variable and constant torque applications



## T1000A

### Multi-Purpose Textile Inverter

**Textile AC Drive**

The T1000A is an inverter drive with current vector control with or without speed sensor. Thanks to specially coated circuit boards, the reliable power failure bridging or the heat sink and fanless version for mounting on a water cooler, the T1000A is perfectly suited for equipping reliable and durable textile machines.

### Features

- High-precision open- and closed-loop-control of induction and permanent magnet motors
- Heat sink and cold plate versions for water cooler mounting available
- Integrated textile functions, e.g. for thread laying and power failure detection/treatment
- Very robust drive for harsh environments, designed for 10 years maintenance-free operation
- Built-in maintenance monitors for IGBT, capacitors or operation time
- Built-in SIL2 / PL-d safety

Technical Data	T1000A
Motor power range [kW]	0.55 – 185
Induction motor (IM)	✓
Permanent magnet motor (PM)	✓

## T1000V

### Compact Textile Inverter

**Textile AC Drive**

The T1000V is the compact solution for applications in the textile industry.



Technical Data	T1000V
Motor power range [kW]	0.1 – 18.5
Induction motor (IM)	✓
Permanent magnet motor (PM)	✓

### Features

- Encoderless control of asynchronous and PM motors
- Heat sink and cold plate versions for water cooler mounting available
- Specially coated PCBs for textile applications
- Compact and cost effective textile solution
- Built-in maintenance monitors for IGBT, capacitors, fan and charging circuit
- Very robust AC drive designed for 10 years continuous and maintenance-free operation



## L1000A

The standard in the elevator industry  
**Lift AC Drive**

The lift AC drive L1000A is the perfect solution for technical requirements of today's lifts. L1000A controls induction and permanent magnet motors and is the first choice for new installations, machine room less lifts and lift modernization.

### Features

- Open- and closed-loop-control for IM and PM motors
- Large power range
- Programming in lift terminology and in 13 languages
- Displays parameter in lift-specific terms and units (m/s, m/s<sup>2</sup> ...)
- Automatic evacuation with UPS system/battery
- Flexible controller interface
- Best ride comfort
- Operation without motor contactors (SIL3 STO)
- DCP3/DCP4/CANLift

Technical Data	L1000A
Motor power range [kW]	1.5 – 110
Induction motor (IM)	√
Permanent magnet motor (PM)	√

## L1000V

Compact Lift AC Drive  
**Lift AC Drive**

The compact L1000V is the economic solution for modernization and new installation of lifts with gear box motors without speed feedback. By sticking to the basics, this Yaskawa AC drive combines usability and outstanding ride performance with a robust and durable design.



Technical Data	L1000V
Motor power range [kW]	4.0 – 15
Induction motor (IM)	√

### Features

- Open-loop-control for induction motors
- Programming in lift terminology and in 8 languages
- State-of-the-art motor control algorithms for a smooth ride and a precise stop
- Designed for long performance and low life-cycle cost
- Preventive maintenance indicator for IGBT, capacitors and cooling fans

# Green Performance Solutions

## R1000



### Energy Saving Regenerative Unit

#### Intelligent Braking Resistor

The R1000 regenerative unit replaces conventional braking resistors in machines and systems and makes braking energy available to other consumers in the same system. This saves energy and reduces costs.

#### Features

- Allows 4-quadrant-operation without braking resistors
- No waste heat due to braking resistors, thus less need for cooling/ventilation, fire hazard and operating costs
- Provides regenerative energy for other consumers in the plant, reducing total power consumption
- Quick amortisation of investments

Model	R1000	D1000	U1000
Energy saving by braking power regeneration	●	●	●
Motor drive	-	-	●
Improve power factor	-	●	●
Suppress input current harmonics	-	●	●
DC voltage boost	-	●	-
Feed-in of multiple drives	○	●	-
Simple wiring	○	○	●
Downsize panel	○	○	●
Integrated Bypass function at 50 Hz	-	-	●

Technical Data	R1000
Regeneration capacity [kW]	3.5–300
Apply to multiple drives	√





## D1000



Regenerative converter unit with low harmonics

### Low Harmonic Energy Recovery Unit

D1000 is a regenerative unit for DC power supply of single drives or systems consisting of AC drives, servos or robots. In addition to the use of braking energy, the D1000 enables particularly efficient and network-friendly system operation.

### Features

- 4-quadrant-operation without braking resistors
- Sinusoidal input current (total harmonic distortion < 5 %) and  $\cos\phi = 1$  minimize losses in cables, transformers and generators and allow an optimal utilization of the system
- Controlled, customizable DC voltage guarantees the same level of DC voltage independent of the power supply voltage (Boost function)
- D1000 reduces the cost for energy and maintenance, which allows for a short payback period
- No waste heat due to braking resistors, thus less need for cooling/ventilation, fire hazard and operating costs

Technical Data	D1000
Power range [kW]	5.0 – 630
Suppress power supply harmonics	✓
Apply multiple drives	✓



## U1000



The AC-to-AC drive for maximum efficiency

### Matrix Converter

The U1000 is a highly efficient inverter drive based on latest Matrix converter technology. With full power regeneration capability it offers great energy saving potential while sinusoidal input currents and a power factor close to one reduce stress on grid components, cables and wires. With an ultra-compact shape, it is the first choice for innovative, energy-efficient drive solutions with or without power regeneration.

### Features

- Innovative Matrix Drive technology without DC bus capacitors up to 500 kW
- Built-in power regeneration
- Extremely compact in comparison with conventional solutions for feedback or low harmonics
- Completely integrated solution minimizes installation and wiring effort
- Built-in bypass operation at 50 Hz
- Maximum flexibility through integrated PLC functionality
- Low-loss and smooth system operation thanks to sinusoidal input current and  $\cos\phi = 1$
- Built-in SIL3 STO function for machine safety
- Induction motor and permanent magnet motor control
- Approved for global marine installation

Technical Data	U1000
Power range [kW]	4 – 500
Suppress power supply harmonics	✓
Apply multiple drives	✓
Induction and PM motor control	✓
Approved for marine installation	BV, ABS, ClassNK, LR, DNV GL, KR





## MP3300 iec & MP3200 iec High Performance Automation Controllers

### Machine Controller

The Yaskawa MP Controller series facilitate a new realm of possibilities in the world of machine control. They provide highest precision even in high speed applications.

Also available as Singular Control version, as MP3300iec RBT.

### Features

- IEC61131-3 programming standard for efficient software programming and -handling
- Control modes: positioning, electronic shaft, speed and CAM
- Acceleration: linear, exponential, with moving average
- Connectors: MECHATROLINK-III, Ethernet (100 Mbps)
- PLCopen function blocks
- Reusable code libraries enable the import of previously developed logic
- Also available as singular control version for easy control of all motion and robotics applications

**ONE  
SOFTWARE  
ONE  
CONTROLLER**

## MP2600 iec IEC on the Drive

### Option Card

The MP2600iec is a small size and powerful controller option for Sigma-7 SERVOPACKs operating a single axis.



### Features

- IEC61131-3 programming standard for efficient software handling
- 1.5 axis control
- Open standards Ethernet/IP and Modbus/TCP
- PLCopen function blocks
- Reusable code libraries enable the import of previously developed logic

### Features

- IEC61131-3 programming standard for efficient software programming and -handling
- Single-axis control
- Connectors: Ethernet/IP & Modbus/TCP
- PLCopen function blocks
- Reusable code libraries enable the import of previously developed logic

## Sigma-7 SIEC IEC on the Drive

### Integrated Machine Controller

The Sigma-7 Siec combines servo electronics and machine control functionality. It is based on a Sigma-7 single-axis SERVOPACK with all its advantages.





## VIPA MICRO

Compact, fast microcontroller system

### Machine Controller

The very compact and extremely fast VIPA MICRO micro-controller system shows completely new ways of operating and status display. The size of the module allows it to be used in almost any automation environment. Via the integrated backplane bus, the Compact CPU with integrated digital and analog IOs can be expanded by up to 8 modules. A PROFINET controller with I-Device function is also integrated.



## VIPA SLIO

Highly modular, compact control system

### Machine Controller

The SLIO control system combines excellent functionality with a clever mechanical concept in an ultra-compact design. The SLIO CPUs are available in a compact version and modular versions with integrated PROFINET controller with I-Device, EtherCAT Master and Modbus TCP Master. The PROFIBUS Master function can optionally be enabled. The CPUs can be expanded with up to 64 SLIO module units via the integrated backplane bus.

## VIPA 300S+

High-Speed Control System

### Machine Controller

With the new 300S+ system family the 300S product family is significantly improved and ultimately replaced. The VIPA 300S+ CPUs have gained in memory size and additional benefits, without adding to the price. The familiar features from the 300S family have also been adopted into the 300S+ family. In the case of service the VIPA 300S CPUs are interchangeable one to one by the respective successor products.



## Sigma-7

Quick – Fast – Reliable

### Servo Drives



The development of the Sigma-7 series focused on three main goals: consistently simple and fast commissioning, maximum machine throughput with high precision and maximum operational reliability. The Sigma-7 series is now also available as a 400V Series. This new generation combines the experience from 25 years of development know-how and 12 million servo systems in the field.

Yaskawa motors offer an excellent power factor: at the same power, they are significantly smaller and reduce heat generation by up to 20%. In combination with the amplifiers, the motors, which feature 24-bit encoders, meet the highest tracking and precision requirements. Sigma-7 SERVOPACKs can replace their predecessors without new mounting holes. This greatly reduces the cost of upgrading and simplifies the transition to a higher level of performance and precision.

Function	200V	400V
Power range	50 W – 15 kW	200 W – 15 kW
Encoder	24 bit absolute	
Protection class	IP67 by default	
Single axis	✓	✓
Dual axis	✓	✓
Rotary motors	One amplifier for all	One amplifier for all
Linear motors		
Direct drive motors		–
Integrated motion controller	✓	✓
Embedded fieldbus	Pulse train / analog input, MECHATROLINK-II, MECHATROLINK-III, EtherCAT, PROFINET	EtherCAT, MECHATROLINK-III, PROFINET



200 V Series



400 V Series

## Sigma-7 Rotary Servomotors

Yaskawa rotary servomotors belong to the most efficient in the industry. The excellent ratio of size to performance and very low temperature development save space and energy in the application and therefore significantly reduce costs.

### SGM7A

200V



- Low inertia, high speed
- 50 W - 7 kW

400V



- Low inertia, high speed
- 200 W - 1.5 kW

### SGM7J



- Medium inertia, high speed
- 50 W - 750 W



- Medium inertia, high speed
- 200 W - 7 kW

### SGM7G



- Medium inertia, high torque
- 300 W - 15 kW



- Medium inertia, high torque
- Available as standard and high-speed models
- 450 W - 15 kW

## Sigma-7 Direct Drive Motors

Yaskawa Direct Drives provide high torque while being compact in size. In combination with the high performance functions of Sigma 7 Servopacks like friction and power ripple compensation they play to their strengths. No power transmitting devices like belts or gears are needed which reduces construction sizes, weight and in the end energy consumption.

### SGM7D

Ideal for applications that require high torque, high precision and high rigidity.

- High inertia
- Built-in high-resolution (24-bit) encoder
- A high allowable load moment of inertia ratio enables application to large loads
- Large center aperture provides more space for wiring connections

#### Features

- Available for 200 V
- Rated torque: 1.3 - 240 Nm
- Max. torque: 5 - 400 Nm
- Max. speed: 48 - 360 min<sup>-1</sup>



Outer Rotor with Core

### SGM7F

Ideal for applications that require downsizing and a shorter takt time.

- Medium inertia
- Built-in high-resolution (24-bit) encoder
- Compact size with small rotor diameter
- Greater speed and torque stability enable high-speed, high-frequency positioning

#### Features

- Available for 200 V
- Rated torque: 2 - 200 Nm
- Max. torque: 6 - 600 Nm
- Max. speed: 250 - 600 min<sup>-1</sup>

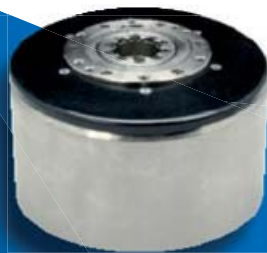

Inner Rotor with Core

### SGM7E

Ideal for applications that require smooth movement without speed fluctuations.

- Low inertia
- Built-in high-resolution (24-bit) encoder
- Smooth operation without speed fluctuations achieved through coreless structure with low cogging

#### Features

- Available for 200 V
- Rated torque: 2 - 35 Nm
- Max. torque: 6 - 105 Nm
- Max. speed: 250 - 500 min<sup>-1</sup>



Coreless, Inner Rotor

## Sigma-7 Linear Motors

Yaskawa is continuously challenging performance barriers with its linear motor products to improve speed and accuracy. Our linear motors improve performance, reliability, speed and accuracy in most automation applications.

### SGLGW2 / SGLFW2

The iron-core linear motors combine high peak forces with a compact design and low energy consumption. The integrated temperature switch provides additional safety. The very low force ripple ensures precise, smooth movement. The automatic regulator tuning in the servo drive means that the linear motor can be put into operation quickly and easily.

#### Features

- Available for 200 V & 400 V
- Peak forces from 135 to 7,560 N
- Optional water cooling system
- Low force ripple

### SGLGW / SGLGM

#### Features

- Available for 200 V
- Peak forces from 40 to 3,000 N
- Lack of magnetic attraction force extends the life of linear motion guides and minimizes noise
- Extremely low force ripple

### SGLFW/ SGLFM

#### Features

- Available for 200 V
- Peak forces from 86 to 5,400 N
- The magnetic attraction force between the moving and stationary members can be used effectively to increase the rigidity of the linear guidance by preloading the linear motion bearings





## MYS-Series 4-Axis Scara Robot

### Picking, Packing & Handling

The MYS series offers superior performance in applications such as assembly, small part handling, case packing and lab automation. The Scara robot easily integrates with existing robot applications to expand current automated processes. It is ideal for large, multi-process systems requiring pick-and-place capability.

### Features

- High speed
- Compact size

Technical Data	MYS-Series
Reach	450 – 850 mm
Payload	6 – 10 kg
Controlled axes	4

## MotoMINI-Series

Small. Lightweight. Fast.

### Handling & General Applications

The MotoMINI 6-axis robot was especially designed for handling and assembly of small work pieces. It reduces the size of your production line and helps to increase productivity.



Technical Data	MotoMINI
Reach	350 mm
Payload	0.5 kg
Controlled axes	6

### Features

- Small and fast
- Lightweight and portable
- Superior performance in small part handling & assembly
- Minimum footprint
- Flexible positioning





## MPX-Series

### 6-Axis Painting Robot

**Painting & Coating**

The MOTOMAN MPX series with hollow wrist is strong enough to accommodate large rotary atomizers. Its process arm and high load capacity allow efficient painting of multiple colors. Due to its extremely compact design, the painting cell is kept small to save space.

### Features

- High painting quality
- Optimized working range
- Flexible installation
- Space-saving

Technical Data	MPX-Series
Reach	727 – 2,700 mm
Payload	5 – 15 kg
Controlled axes	6

## GP-Series

### High-Speed, 6-Axis Robot

**Handling & General Applications**

The 6-axis MOTOMAN MH-series are versatile, powerful robots offering superior performance for a variety of applications. It provides a high payload of up to 600 kg and a wide motion range of up to 2,942 mm, which especially enables the handling of large and heavy work pieces.



Technical Data	GP-Series
Reach	532 – 2,942 mm
Payload	7 – 600 kg
Controlled axes	6

### Features

- High speed
- Extremely broad range of products
- Compact size
- Compact and powerful



## SDA-Series 15-Axis Dual-Arm Robot

### Flexible Applications

The SDA is a slim and agile 15-axis dual-arm robot providing “human-like” flexibility of movement and fast acceleration. Its powerful actuator based design with high wrist performance and fully integrated supply cables, makes it ideal for a wide variety of operations such as assembly, part transfer, machine tending, packaging and other handling tasks that formerly could only be done by people. Both robot arms can synchronously work together or simultaneously perform tasks independently. Due to its small footprint it can operate in confined spaces, saving valuable floor space.

### Features

- High flexibility
- High speed
- Compact design allows maximum performance

Technical Data	SDA-Series
Reach	854 – 1,313 mm
Payload	5 – 20 kg
Axes	15

## SIA-Series 7-Axis Single-Arm Robot

### Flexible Applications

The slim and powerful MOTOMAN SIA 7-axis single-arm robot is perfect for automated processes such as assembly, inspection, machine tending and material handling. The revolutionary design with high wrist performance and internal supply cables make it possible to use it in confined spaces while providing unrivalled manoeuvring flexibility. It is even able to easily move around corners or reach into the machine.



Technical Data	SIA-Series
Reach	559 – 1,485 mm
Payload	5 – 50 kg
Axes	7

### Features

- High flexibility
- High speed
- Compact design allows maximum performance



## ES- / MS- / VS-Series

### 6- & 7-Axis Welding Robots

#### Robots for spot welding

The MOTOMAN ES is a versatile, high-speed robot offering superior performance in spot welding, material handling, machine tending and press tending. The ES robot offers a large work envelope and a high moment of inertia ratings. Fast axial speeds and acceleration reduce cycle times and increase production output. The compact, slim design allows the robot to reach into confined spaces, improving system productivity.

The MOTOMAN VS100 provides a unique, slim design which optimizes automotive spot welding applications. It is the industry's first 7-axis spot welding-robot which offers a highly flexible range of motion.

#### Features

- Fast, flexible and powerful
- High dynamic performance
- Ideal for spot welding, machine tending and material handling

Technical Data	ES- / MS- / VS-Series
Reach	2,236 – 3,140 mm
Payload	80 – 210 kg
Axes	7

## MA-Series

### Welding Robots

#### Robots for arc welding

The 6-axis MOTOMAN MA robots have been developed in order to achieve optimal results in extremely difficult conditions and especially for the high demands of arc welding applications.

The high-precision tracking and integrated supply lines prevent collisions with workpieces and other robots in the room and minimise wear to the torch hose package. Fast motion sequences reduce welding cycle times.



#### Features

- High precision
- High speed
- Easy maintenance

Technical Data	MA-Series
Reach	1,440 – 2,010 mm
Payload	6 – 10 kg
Axes	6



## MPP 3- & MPK-Series

### Pick & Place Robots

#### Handling, Picking, Packing

The 4-axis high-speed robot MOTOMAN MPP3 with parallel kinematic system combines the speed of the delta design with a high payload capacity and a large working range.

The MOTOMAN MPK is a high-speed, 5-axis picking robot that provides superior performance and reliability for food handling, picking, packing and other high-speed material handling applications.

### Features

- Minimal footprint
- Fast acceleration and high speed increase productivity
- Optional vision and conveyor tracking for maximum flexibility

Technical Data	MPP3- & MPK-Series
Reach	860 – 1,893 mm
Payload	3 – 50 kg
Axes	4 – 5

## MPL-Series

### 4- & 5-Axis Palletising Robots

#### Palletising Robots

The innovative, 4-axis palletizing robot MPL100 with its payload of up to 800 kg is a dynamic masterful mover and stands out due to its extremely high acceleration and axis speed values. Another important criterion is the low space requirement.



Technical Data	MPL-Series
Reach	2,061 – 3,159 mm
Payload	80 – 800 kg
Axes	4 – 5

### Features

- Compact design
- High acceleration
- Increased durability of hose package by internal cable wiring

## VIPA SLIO I/O-System

The SLIO I/O system is highly modular and at the same time very compact. It is designed for decentralized automation tasks. The interface module with integrated backplane bus forms the basis for this, on which up to 64 module units can be added. The interface module is available with numerous fieldbus interfaces such as PROFINET, EtherCAT, Ethernet IP, Modbus TCP, MECHATROLINK-III, PROFIBUS, CANopen and DeviceNet. Integration into a higher-level system is done via the device description file.

## VIPA Touch Panels

The VIPA professionalPanels with 4.3" to 12.1" TFT-Display, Windows Embedded CE 6.0 operating system and Movicon 11 visualization system can be used universally.

The new VIPA panel series cloudPanel and smartPanel with display sizes of 4.3", 7" and 10" not only provide a fresh breeze on the automation market with their new design, but also have many new features in their luggage. During development, the company deliberately focused on future technologies like cloud, WebVisu and similar.

## VIPA PanelPCs

The VIPA PanelPCs with display sizes 10.1", 15.6" and 21.5" are a combination of an industrial PC with state-of-the-art performance features and a touch panel with optimal displaying options. The required performance is provided by an Intel Celeron quad-core processor, optionally with Windows Standard 7 or Windows Compact 7 as operating system and Movicon 11.5 Runtime and Editor for the visualization application.



## VIPA Remote Access

Teleservice modules offer access to your machines and plants worldwide as if you were on site. The modules are designed for all modern communication systems.



## VIPA Industrial Ethernet

Ethernet Switches with 5 or 8 ports Unmanaged are entrylevel models which support the IEEE 802.3 / 802.3u / 802.3x with 10/100M, full-/half-duplex and RJ45 ports with automatic MDI/MDIX recognition. For PROFINET networks there are Managed PROFINET switches with 5 or 8 ports available.



## VIPA Fieldbus

The PROFIBUS repeater family consists of advanced, flexible and robust network components for PROFIBUS DP installations. This allows the implementation of long spur lines with many users and network structures with star-/tree-shaped segments.





### **Drives Motion Controls**

YASKAWA Europe GmbH  
Hauptstraße 185  
65760 Eschborn  
GERMANY  
+49 6196 569-500  
info@yaskawa.eu.com  
www.yaskawa.eu.com

VIPA – Gesellschaft für Visualisierung  
und Prozessautomatisierung GmbH  
Ohmstraße 4  
91074 Herzogenaurach  
GERMANY  
+49 9132 744-0  
info@vipa.de  
www.vipa.com

### **Robotics**

YASKAWA Europe GmbH  
Yaskawastraße 1  
85391 Allershausen  
GERMANY  
+49 8166 90-0  
robotics@yaskawa.eu.com  
www.yaskawa.eu.com

### **Environmental Energy**

The Switch  
Elimäenkatu 17 – 19  
FI-00510 Helsinki  
FINLAND  
+358 20 783 8200  
info@theswitch.com  
www.theswitch.com