



# MACHINE CONTROLLER

## MP2300Siec



EN  
D  
E  
F  
I

MP2300Siec  
MP2300Siec  
MP2300Siec  
MP2300Siec

## About YASKAWA



## Contents

- ▶ **Page 2**  
About YASKAWA  
What we do
- ▶ **Page 3**  
YASKAWA Motion Controller  
MP2300Siec  
Features & benefits  
YASKAWA IEC environment  
About YASKAWA Controller
- ▶ **Page 4**  
Specifications
- ▶ **Page 5**  
Modules
- ▶ **Page 6**  
Applications
- ▶ **Page 7**  
MECHATROLINK

For more than 90 years YASKAWA has been supplying mechatronic products and is one of the leading companies for Motion Control products worldwide. YASKAWA develops and manufactures Inverter Drives, Servo Drives and Motion Controllers and has introduced many

### What we do

Electronic drive technology, Motion Control, system engineering – three essentials for efficient and resource-saving production systems.

YASKAWA offers dedicated mechatronic solutions for industries such as packaging, lifting & handling, semiconductors, cranes & hoists, textiles, HVAC/fans & pumps, lifts & escalators, machine tools, woodworking, food & beverages and the automotive industry.

Since it was founded about 100 years ago YASKAWA has shaped technological innovation and the industrial development of our times. Today YASKAWA is one of the leading worldwide manufacturers of motors and drives, factory automation products and robots. Standard products as well as customised solutions from YASKAWA have gained broad acceptance and recognition in global markets.

Since 1963 YASKAWA has continuously developed its European business and expanded its market share. In 1998, the company completed its global production network for localised market supply by establishing a European factory in Cumbernauld, Scotland.

ground-breaking innovations over the past decades. YASKAWA products are used in all fields of machine building and industrial automation and have a high reputation for their outstanding quality and durability.

Well known for outstanding quality standards, YASKAWA serves and supports customers all over the world as a competent and qualified partner. Together with subsidiaries and partners, YASKAWA provides international distribution networks including offices and production facilities in 25 countries to react instantly within 24 hours to customer demands.

YASKAWA key competences:

- ▶ Leading edge technologies in the fields of electric motors and drives, factory automation control products, mechatronics and robots
- ▶ Business network includes offices in 24 countries & production facilities in 6 countries
- ▶ Technology research & development to pursue innovation in mechatronics and automation technology as well as information technologies



## YASKAWA Motion Controller MP2300Siec

The MP2300Siec facilitates a new realm of possibilities in the world of machine control. By combining many proven technologies into one platform, YASKAWA offers a powerful system with ample flexibility.

Governed by internationally standardized functions, the MP2300Siec is a machine controller with a potent motion engine at its core. It includes a built-in web server and is compatible with international network protocols.

YASKAWA superior-quality hardware driven by industry standard programming tools maximizes the total automation system value.

## YASKAWA IEC programming environment

Many programming languages exist today. Few excel at providing an environment for easily coding ALL the functionality of modern automated machinery.

That's where YASKAWA IEC61131-3 programming environment shines. MotionWorks IEC encourages the programmer to take advantage of the best of several programming languages within one development package.

Ladder Logic is perfect for representing digital sensory data. Structured Text is a great solution for mathematical algorithms and assignments, while Function Block Diagrams are best suited for motion control. These languages seamlessly and predictably cooperate with one another. Variables and outputs from a program structure can be referenced by other programs, providing the ultimate automation development environment..

### YASKAWA MP2300Siec Features & Benefits

- ▶ **Communication Protocols** – Open standards EtherNet/IP and Modbus/TCP to connect to many HMI and PLC in the market.
- ▶ **Standard Programming Languages** – IEC61131-3 standard for efficient software programming and handling
- ▶ **PLCopen Function Blocks** – YASKAWA developed the Motion Control interface MotionWorks IEC to comply with PLCopen "standard".
- ▶ **Programmable Amplifier Outputs** – The controller can operate local amplifier outputs. This reduces panel cost and space requirements when just a couple of outputs are necessary.
- ▶ **Reusable Code** – Libraries enable importation of previously developed logic.
- ▶ **Controller-Centric Commissioning** – The MECHATROLINK motion network enables machine configuration from a single location with one software tool. Using self-tuning abilities of a servo system commissioning time is greatly reduced.
- ▶ **A Multitude of Options** – Choose from ten option cards offered for the expansion slot to accommodate most machine requirements.

#### Configuration tool

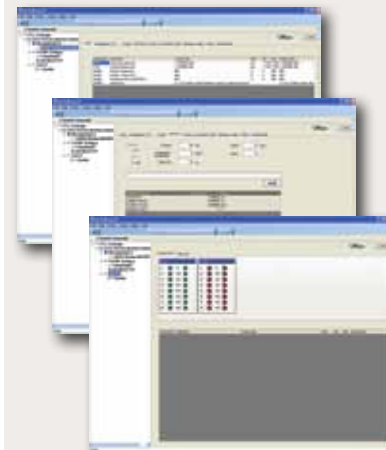

#### Motionworks IEC



#### Webserver



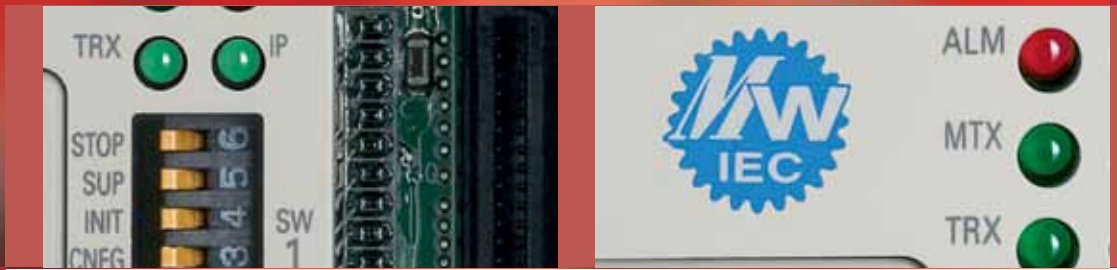

# Specifications

Units: mm

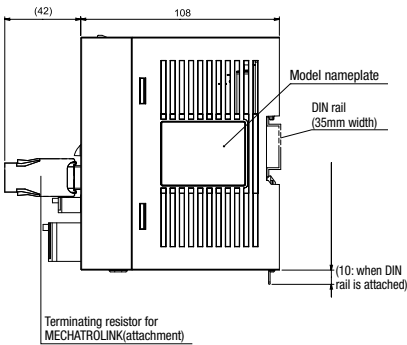
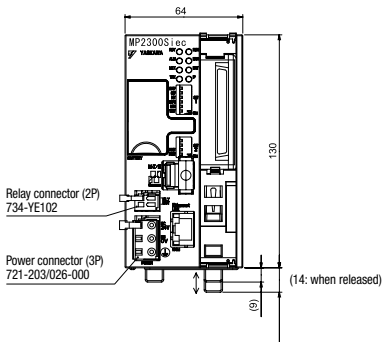
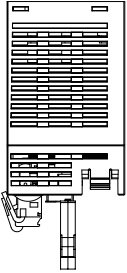









Features	Description
<b>Program Capacities</b>	<ul style="list-style-type: none"> <li>▶ Standard programming languages IEC61131-3</li> <li>▶ PLCopen function blocks</li> <li>▶ One open slot for the optional modules</li> <li>▶ Webserver/OPC-server</li> </ul>
<b>Number of controlled Axis</b>	4-8-16 axes
<b>Control Functions</b>	Position control, gearing, speed control, torque control
<b>Accel/decel processing</b>	Linear
<b>Program languages</b>	<ul style="list-style-type: none"> <li>▶ IEC61131-3 languages</li> <li>▶ Ladder Diagram, Function Block Diagram, Instruction List, Structured Text, Sequential Function Chart</li> <li>▶ Express: Ladder Diagram, Structured Text</li> </ul>
<b>I/O</b>	Can be extended by I/O module and distributed I/O
<b>Communication</b>	<ul style="list-style-type: none"> <li>▶ MECHATROLINK</li> <li>▶ Ethernet (100 Mbps)</li> </ul>
<b>International standard</b>	UL, c-UL, CE (for further information, contact YASKAWA Europe GmbH)

Item		Specifications
<b>Control Functions</b>	Ambient Operating Temperature	0 to 55°C
	Ambient Storage Temperature	-25 to 85°C
	Ambient Operating Humidity	30 to 95% (with no condensation)
	Ambient Storage Humidity	5 to 95% (with no condensation)
	Pollution Level	Pollution Level 1 (Conform to JIS B 3501)
	Corrosive Gas	There must be no combustible or corrosive gas
	Operating Altitude	2,000 m above sea level or lower
<b>Protection Function</b>	Vibration Resistance	Conforming to JIS B 3502: <ul style="list-style-type: none"> <li>▶ 10 to 57 Hz with single-amplitude of 0.075 mm</li> <li>▶ 57 to 150 Hz with fixed acceleration of 9.8 m/s<sup>2</sup></li> <li>▶ 10 sweeps each in X, Y, and Z directions (sweep time: 1 octave/min)</li> </ul>
	Shock Resistance	Conforming to JIS B 3502: Peak acceleration of 147 m/s <sup>2</sup> (15 G) twice for 11 ms each in the X, Y, and Z directions
<b>Electrical Operating Conditions</b>	Noise Resistance	Conforming to EN 61000-6-2, EN 55011 (Group 1, Class A) <ul style="list-style-type: none"> <li>▶ Power supply noise (FT noise): 2 kV min., for one minute</li> <li>▶ Radiation noise (FT noise): 1 kV min., for one minute</li> </ul>
<b>Installation Requirements</b>	Ground	Ground to 100 Ω Max.
	Cooling Method	Natural convection cooling



# Modules

Group		Name	Description	Model	Specifications	
Option Modules	Motion Module	Pulse Output Motion Module	▶ PO-01	▶ JAPMC-PL2310-E	▶ Pulse output ▶ Max 4 axes	
	I/O Modules		Analogue Input Module	▶ AI-01	▶ JAPMC-AN2300-E	▶ Analogue input ▶ 8 channels
			Analogue Output Module	▶ AO-01	▶ JAPMC-AN2310-E	▶ Analogue output ▶ 4 channels
			Output Module	▶ DO-01	▶ JAPMC-DO2300-E	▶ 64 outputs (sink mode output)
			Encoder Module	▶ CNTR-01	▶ JAPMC-PL2300-E	▶ 2 channels Functions: ▶ reversible counter ▶ interval counter ▶ frequency measurement
			I/O Module	▶ LI0-01	▶ JAPMC-I02300-E	▶ 16 digital inputs ▶ 16 digital outputs (sink mode output) ▶ 1 pulse input
			I/O Module	▶ LI0-02	▶ JAPMC-I02301-E	▶ 16 digital inputs ▶ 16 digital outputs (source mode output) ▶ 1 pulse input
			I/O Module	▶ LI0-04	▶ JAPMC-I02303-E	▶ 32 digital inputs ▶ 32 digital outputs (sink mode output)
			I/O Module	▶ LI0-05	▶ JAPMC-I02304-E	▶ 32 inputs ▶ 32 outputs (source mode output)
			Multi-function Option Card	▶ LI0-06	▶ JAPMC-I02305-E	▶ 8 digital inputs ▶ 8 digital outputs (sink mode output) ▶ 1 analogue input ▶ 1 analogue output Pulse counter ▶ 1 channel/encoder input

## Sigma-5 AC Servo Drives

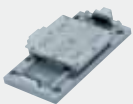

### Sigma-5 – New Servo-Drive Series from YASKAWA: highest accuracy, easiest set-up and unlimited connectivity

The new Sigma-5 series offers rotary, direct drive and linear motors. The rotary servo motor range will be available in several performance categories between 0.1 and 15 kW. They cover all market demands with regard to compact size, high dynamics, high efficiency, low maintenance and outstanding reliability.

The most impressive feature of the Sigma-5 series is its positioning accuracy of up to 10 nm with standard products, while offering shortest positioning times. In addition, the well known autotuning function was optimised for the most sophisticated applications.

Example: The new autotuning algorithm allows the perfect set-up of a two axes in super high performance machine in less than two hours – compared to more than eight hours needed by other products in the market.

In short, Sigma-5 offers precise positioning at highest speed, smooth, vibration-free operation and easiest start up. For machine builders this means:

- ▶ Shortest cycle time – highest throughput
- ▶ Better product quality
- ▶ Less machine wear
- ▶ Shortest initial set-up time
- ▶ Lowest lifecycle cost

### Suitable for many applications

The major benefits of Sigma-5, such as precise and fast positioning, highest machine speed, vibration less motion, smooth running at lowest speed, make Sigma-5 ideal for machines in the fields of electronics, semiconductors, packaging, printing and machine tools. The new Sigma-5 generation will also be a perfect match for the injection moulding and metal forming industries, where high throughput and point-to-point positioning are decisive factors.





**MECHATROLINK is the key technology for your system. Through total component integration, Mechatrolink reduces wiring. It enables the set-up of multi-function and high-performance systems while simplifying tuning and maintenance of the system. MECHATROLINK is used in a wide variety of applications to simplify work processes and to save time and money.**

### System efficiency

For MECHATROLINK, a vast variety of controllers, servo drives and stepper drives is available. This makes it an ideal choice for most machines in the market. The Mechatrolink logo on a product guarantees that it is interoperable with other MECHATROLINK products.

### High-speed communication

High-speed communication provides high-performance and high-accuracy Motion Control because data for the actual position, speed, input/output status and other parameters are communicated in real-time.

### Reduced cost

Just one communication line can connect up to 21 stations in a network. This can greatly reduce costs and wiring time. With connectors and cables used in the process and factory automation fields, MECHATROLINK makes the most reliable, versatile and economically efficient systems. It simplifies a Motion Control system so that it no longer requires the A/D converter for velocity/torque reference nor the pulse generator for position reference.

### MECHATROLINK Members Association (MMA) Global Support and Product Development



To assist the development of new MECHATROLINK products, the MECHATROLINK Members Association (MMA) offers technical support to board, executive and regular members.

All members can download technical information on <http://www.mechatrolink.org>. MMA support enables the development of new compliant products without unnecessary complications.

### MECHATROLINK Applications

MECHATROLINK can be used for the control of a variety of high precision machines. It is especially suitable for synchronous and interpolation motion controls. MECHATROLINK enables the user to perfectly control torque, velocity and positioning even in complex movements.

- ▶ Cutting machines
- ▶ Press brakes
- ▶ Plastic tape processors
- ▶ Laser welders
- ▶ X-Z processing systems
- ▶ Winding machines
- ▶ Labelling machines
- ▶ Chip mounters and handling robots
- ▶ Printing machines



**YASKAWA Europe GmbH**

Drives & Motion Division  
Hauptstr. 185  
65760 Eschborn  
Germany

+49 6196 569-300  
info@yaskawa.eu.com  
www.yaskawa.eu.com

International Standards



RoHS Directive

RoHS Directive Exemption for the FULfillment of the Restriction of the Use of Certain Hazardous Substances in Electrical and Electronic Equipment



Specifications are subject to change without notice for ongoing product modifications and improvements.  
© YASKAWA Europe GmbH. All rights reserved.

Literature No. YEU\_MuC\_MP2300SIEC\_EN\_v2\_1110  
Printed in Germany November 2010