



YASKAWA

YASKAWA AC Drive-Option LCD Operator Installation Manual

Type JVOP-180

To properly use the product, read this manual thoroughly and retain for easy reference, inspection, and maintenance. Ensure the end user receives this manual.

安川インバータ オプション LCDオペレータ 取扱説明書

形式 JVOP-180

製品を安全にお使い頂くために、この取扱説明書を必ずお読みください。
また、本書をお手元に保管していただくとともに、最終的に本製品をご使用になるユーザー様のお手元に確実に届けられるよう、お取り計らい願います。

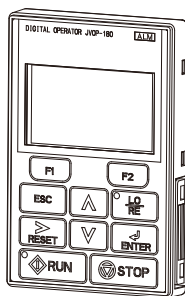



Table of Contents

1 PREFACE AND SAFETY	4
2 PRODUCT OVERVIEW	9
3 RECEIVING	11
4 LCD OPERATOR OPTION COMPONENTS	13
5 INSTALLATION PROCEDURE	20
6 BASIC OPERATION	25
7 RELATED PARAMETERS	33
8 LCD OPERATOR OPTION FAULT DIAGNOSTICS	35
9 SPECIFICATIONS	37
10 REVISION HISTORY	38

Copyright © 2007 YASKAWA ELECTRIC CORPORATION

All rights reserved. No part of this publication may be reproduced, stored in a retrieval system, or transmitted, in any form or by any means, mechanical, electronic, photocopying, recording, or otherwise, without the prior written permission of Yaskawa. No patent liability is assumed with respect to the use of the information contained herein. Moreover, because Yaskawa is constantly striving to improve its high-quality products, the information contained in this manual is subject to change without notice. Every precaution has been taken in the preparation of this manual. Yaskawa assumes no responsibility for errors or omissions. Neither is any liability assumed for damages resulting from the use of the information contained in this publication.

1 Preface and Safety

Yaskawa manufactures products used as components in a wide variety of industrial systems and equipment. The selection and application of Yaskawa products remain the responsibility of the equipment manufacturer or end user. Yaskawa accepts no responsibility for the way its products are incorporated into the final system design. Under no circumstances should any Yaskawa product be incorporated into any product or design as the exclusive or sole safety control. Without exception, all controls should be designed to detect faults dynamically and fail safely under all circumstances. All systems or equipment designed to incorporate a product manufactured by Yaskawa must be supplied to the end user with appropriate warnings and instructions as to the safe use and operation of that part. Any warnings provided by Yaskawa must be promptly provided to the end user. Yaskawa offers an express warranty only as to the quality of its products in conforming to standards and specifications published in the Yaskawa manual. **NO OTHER WARRANTY, EXPRESSED OR IMPLIED, IS OFFERED.** Yaskawa assumes no liability for any personal injury, property damage, losses, or claims arising from misapplication of its products.

◆ Applicable Documentation

The following manuals are available for the JVOP-180 LCD Operator Option:

LCD Operator	
	YASKAWA AC Drive-Option LCD Operator Installation Manual
	<p>Read this manual first.</p> <p>The installation manual is packaged with the LCD Operator Option and contains a basic overview of wiring, settings, functions, and fault diagnoses.</p>

For the drive setup, refer to the drive Quick-Start Guide or Technical Manual.

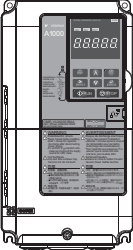
Yaskawa Drive	
	<p>Refer to the manual of the drive this option is being used with.</p> <p>The manual for the drive covers basic installation, wiring, operation procedures, functions, troubleshooting, and maintenance information.</p> <p>It also includes important information on parameter settings and how to tune the drive.</p> <p>To obtain instruction manuals for Yaskawa products access these sites: Europe: http://www.yaskawa.eu.com Japan: http://www.e-mechatronics.com Other areas: contact a Yaskawa representative.</p>

Note: Check the LCD operator to make sure it is compatible with the A1000 drive. The nameplate on the LCD operator must list software number PRG 0101 or later for compatibility with A1000.

◆ Terms

Note:	Indicates a supplement or precaution that does not cause drive damage.
≥ 1012:	Indicates a drive feature or function that is only available in drive software version 1012 or greater.
LED:	Light emitting diode.
LCD:	Liquid crystal display.

1 Preface and Safety

◆ Registered Trademarks

Company names and product names listed in this manual are the registered trademarks of those companies.

◆ Supplemental Safety Information

Read and understand this manual before installing, operating or servicing this option unit. The option unit must be installed according to this manual and local codes.

The following conventions are used to indicate safety messages in this manual. Failure to heed these messages could result in serious or possibly even fatal injury or damage to the products or to related equipment and systems.

DANGER

Indicates a hazardous situation, which, if not avoided, will result in death or serious injury.

WARNING

Indicates a hazardous situation, which, if not avoided, could result in death or serious injury.

CAUTION

Indicates a hazardous situation, which, if not avoided, could result in minor or moderate injury.

NOTICE

Indicates an equipment damage message.

1 Preface and Safety

■ General Safety

General Precautions

- The diagrams in this section may include option units and drives without covers or safety shields to illustrate details. Be sure to reinstall covers or shields before operating any devices. The option board should be used according to the instructions described in this manual.
- Any illustrations, photographs, or examples used in this manual are provided as examples only and may not apply to all products to which this manual is applicable.
- The products and specifications described in this manual or the content and presentation of the manual may be changed without notice to improve the product and/or the manual.
- When ordering a new copy of the manual due to damage or loss, contact your Yaskawa representative or the nearest Yaskawa sales office and provide the manual number shown on the front cover.

DANGER

Heed the safety messages in this manual.

Failure to comply will result in death or serious injury.

The operating company is responsible for any injuries or equipment damage resulting from failure to heed the warnings in this manual.

NOTICE

Do not expose the drive to halogen group disinfectants.

Failure to comply may cause damage to the electrical components in the option unit.

Do not pack the drive in wooden materials that have been fumigated or sterilized.

Do not sterilize the entire package after the product is packed.

2 Product Overview



◆ About This Product

The LCD Operator Option provides an enhanced drive user interface that can operate the Yaskawa drive at a short distance up to 3 meters. The LCD Operator Option can display information in eight languages, including English, Japanese, and Spanish. The LCD Operator Option is an LCD display that simplifies the task of interfacing with the drive to perform these tasks:

- Read or modify drive parameters.
- Read and copy drive parameter settings to another Yaskawa drive.
- Operate the drive.
- Monitor drive operation status.

Note: When the LCD Operator Option is installed and connected to the V1000 it will cause the drives built-in LED operator to display a series of dots as shown in [Table 1](#). This is normal operation. Additionally, all keys except for the STOP key on the drives built-in LED operator will not function when the LCD Operator Option is connected. If desired, to also disable the STOP key on the drives built-in LED operator, set parameter o2-02 (STOP Key Function Selection) to 0 (Disabled).

Table 1 Built-in LED Display When LCD Operator is Connected to V1000

Display	LED Display	Drive Status
	Illuminated	During Stop
	Flashing	During Run

2 Product Overview

◆ Applicable Models

The LCD Operator Option can be used with the drive models in [Table 2](#).

Table 2 Applicable Drive Models

Drive	Drive Software Version <1>
A1000	≥ 1010
V1000	≥ 1012

<1> See “PRG” on the drive nameplate for software version number.

Note: Check the LCD operator to make sure it is compatible with the A1000 drive. The nameplate on the LCD operator must list software number PRG 0101 or later for compatibility with A1000.

3 Receiving

Perform the following tasks after receiving the LCD Operator Option:

- Inspect the LCD Operator Option for damage.
If the LCD Operator Option appears damaged upon receipt, contact the shipper immediately.
- Verify receipt of the correct model by checking the model number printed on the Name plate of the LCD Operator Option.
- If you have received the wrong model or the LCD Operator Option does not function properly, contact your supplier.

◆ Contents and Packaging

Table 3 Contents of Package

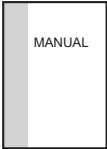
Description:	LCD Operator Option	Installation Manual
		
Quantity:	1	1

■ Additional Part Required (Sold Separately)



Proper installation of the LCD Operator Option requires a communication cable. A communication cable is not provided. A connection cable can be purchased from Yaskawa or recommended LAN cables may be used. Refer to [Table 4](#) for more information regarding the cable required for your application.

Depending on the LCD Operator Option installation method, an installation support listed in [Table 4](#) may also be required. [Refer to Installing the LCD Operator Option on page 21](#) for more information regarding installation methods.

To order a cable or an installation support, contact Yaskawa directly or your nearest Yaskawa distributor.

3 Receiving

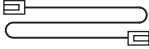
Table 4 Item Names and Part Numbers (Sold Separately)

Item	Yaskawa Part Number	Notes	Page
 Communication Cable (1 m)	WV001 <2>	Sold Separately	24
 Communication Cable (3 m)	WV003 <2>	Sold Separately	24
 Installation Support Set A	EZZ020642A	Sold Separately; For use with holes through the panel	22
 Installation Support Set B <1>	EZZ020642B	Sold Separately; For use with panel mounted threaded studs	23

<1> If weld studs are on the back of the panel, use the Installation Support Set B.

<2> Alternate cables (customer supplied), RJ45 8 pin Straight Connector UTP Cat 5e cable.

◆ Tool Requirements

To install the LCD operator on the door of the enclosure panel, the following tools are required:

Table 5 Required Tools

Installation Location	Installation Support	Required Tools
External/Face Mount	–	Phillips screwdriver, M3
Internal/Flush Mount	Installation Set A	Phillips screwdriver, M3, M4
	Installation Set B	Phillips screwdriver, M3 Box end or adjustable wrench, M4

4 LCD Operator Option Components

◆ LCD Operator Option

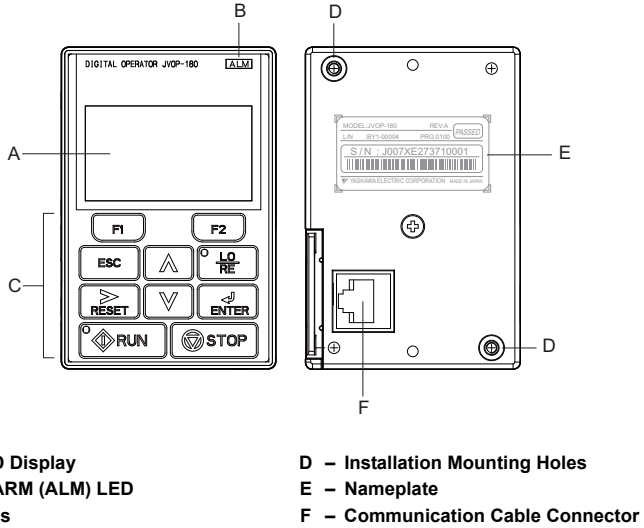

Figure 1 LCD Operator Option Components

4 LCD Operator Option Components

◆ Keys

Refer to [Figure 2](#) and [Table 6](#) for details on key names and functions.

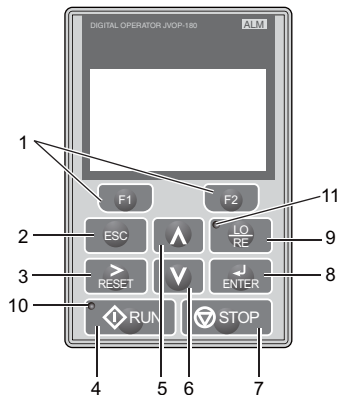













Figure 2 Keys

Table 6 Key Names and Functions

No.	Key	Name	Function
1	 	Function Key (F1, F2)	The functions assigned to F1 and F2 vary depending on the menu that is currently displayed. The name of each function appears in the lower half of the display window. For a description of functions assigned to the F1 and F2 keys, Refer to LCD Display on page 17 .
2		ESC Key	<ul style="list-style-type: none"> Returns to the previous display. Moves the cursor one space to the left. Pressing and holding this button will return to the Frequency Reference display.
3		RESET Key	<ul style="list-style-type: none"> Moves the cursor to the right. Resets the drive to clear a fault situation.
4		RUN Key	Starts the drive and motor.







4 LCD Operator Option Components

No.	Key	Name	Function
5		Up Arrow Key	Scrolls up to display the next item, selects parameter numbers and increments setting values.
6		Down Arrow Key	Scrolls down to display the next item, selects parameter numbers and increments setting values.
7		STOP Key	Stops drive operation. Note: The STOP key can be enabled or disabled when operating from the external terminal or network communications by setting parameter o2-02.
8		ENTER Key	<ul style="list-style-type: none"> Enters parameter values and settings. Selects a menu item to move between displays.
9		LO/RE Selection Key	Switches the drive between operator (LOCAL) control and control circuit terminals (REMOTE). Note: The LOCAL/REMOTE key is only effective at a stop in drive mode. As a safety precaution, it is possible to disable the LO/RE Selection Key by setting parameter o2-01 (LOCAL/REMOTE Key Function Selection) to "0" (disabled).
10		RUN Light	Illuminated while the drive is operating the motor. <i>Refer to LCD Operator LED Status Indicators on page 16 for detail.</i>
11		LO/RE Light	Illuminated while the drive is under LCD Operator control when (LOCAL) is selected to run the drive.

4 LCD Operator Option Components

◆ LCD Operator LED Status Indicators

Table 7 LED Status and Meaning

LED	Illuminated	Flashing < >	Flashing Quickly < >	Off
LO/RE LED 	When the run command is selected from the LCD operator (LOCAL).	—	—	Run command is selected from a device other than the LCD operator (REMOTE).
RUN LED 	During run.	<ul style="list-style-type: none"> During deceleration to stop. When a run command is input and the frequency reference is 0 Hz. 	<ul style="list-style-type: none"> During deceleration at a fast-stop. During stop by External Fault digital input. 	During stop.
As shown				

<|> For the difference between “Flashing” and “Flashing Quickly” of the RUN LED, refer to [Figure 3](#), RUN LED Status.

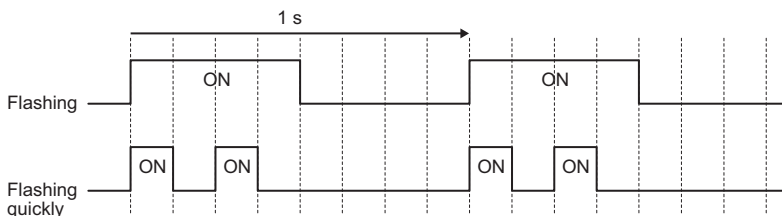

Figure 3 RUN LED Status

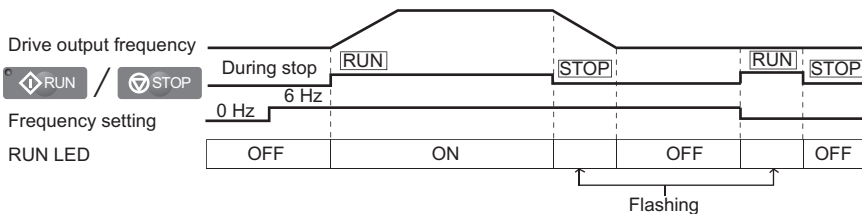

Figure 4 RUN LED and Drive Operation

◆ LCD Display

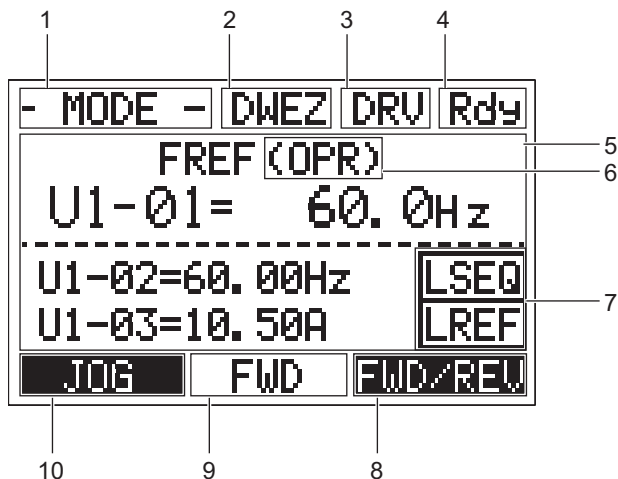











Figure 5 LCD Display

Table 8 Display and Contents

No.	Name	Display	Content
1	Operation Mode Menus	MODE	Displayed when in Mode Selection.
		MONITR	Displayed when in Monitor Mode.
		VERIFY	Indicates the Verify Menu.
		PRMSET	Displayed when in Parameter Setting Mode.
		A.TUNE	Displayed during Auto-Tuning.
		SETUP	Displayed when in Setup Mode.
2	DriveWorksEZ Function Selection	DWEZ	Displayed when the DriveWorksEZ is set to enable. (A1-07=1 or 2)
3	Mode Display Area	DRV	Displayed when in Drive Mode.
		PRG	Displayed when in Programming Mode.
4	Ready	Rdy	Indicates the drive is ready to run.
5	Data Display	-	Displays specific data and operation data.

4 LCD Operator Option Components



No.	Name	Display	Content
6	Frequency Reference Assignment <1>	OPR	Displayed when the frequency reference is assigned to the LCD Operator Option.
		AI	Displayed when the frequency reference is assigned to the drives Analog Input.
		COM	Displayed when the frequency reference is assigned to the drives MEMOBUS/Modbus Communication Inputs.
		OP	Displayed when the frequency reference is assigned to a drive Option Unit.
		RP	Displayed when the frequency reference is assigned to the drives Pulse Train Input.
7	LO/RE Display <2>	RSEQ	Displayed when the run command is supplied from a remote source.
		LSEQ	Displayed when the run command is supplied from the operator keypad.
		RREF	Displayed when the frequency reference is supplied from a remote source.
		LREF	Displayed when the frequency reference is supplied from the operator keypad.
8	Function Key 1 (F1)	JOG	Pressing  executes the Jog function.
		HELP	Pressing  displays the Help menu.
		←	Pressing  scrolls the cursor to the left.
		HOME	Pressing  returns to the top menu (Frequency Reference).
		ESC	Pressing  returns to the previous display.
9	FWD/REV	FWD	Indicates forward motor operation.
		REV	Indicates reverse motor operation.
10	Function Key 2 (F2)	FWD/REV	Pressing  switches between forward and reverse.
		DATA	Pressing  scrolls to the next display.
		→	Pressing  scrolls the cursor to the right.
		RESET	Pressing  resets the existing drive fault or error.

<1> Displayed when in Frequency Reference Mode.

<2> Displayed when in Frequency Reference Mode and Monitor Mode.

◆ ALARM (ALM) LED Displays

Table 9 ALARM (ALM) LED Status and Contents

State	Content	Display
Illuminated	When the drive detects an alarm or error.	
Flashing	<ul style="list-style-type: none"> • When an alarm occurs. • When oPE is detected. • When a fault or error occurs during Auto-Tuning. 	
Off	Normal operation (no fault or alarm).	

5 Installation Procedure

◆ Section Safety

NOTICE

Damage to Equipment

Use only Yaskawa connection cables or recommended cables.

Failure to comply may cause the drive or LCD Operator Option to function incorrectly.

Properly connect the connectors.

Failure to comply may prevent proper operation and possibly damage equipment.

Do not exceed communication cable bend radius specifications.

Failure to comply may result in broken wires or loose connections.

◆ LCD Operator Option Dimensions

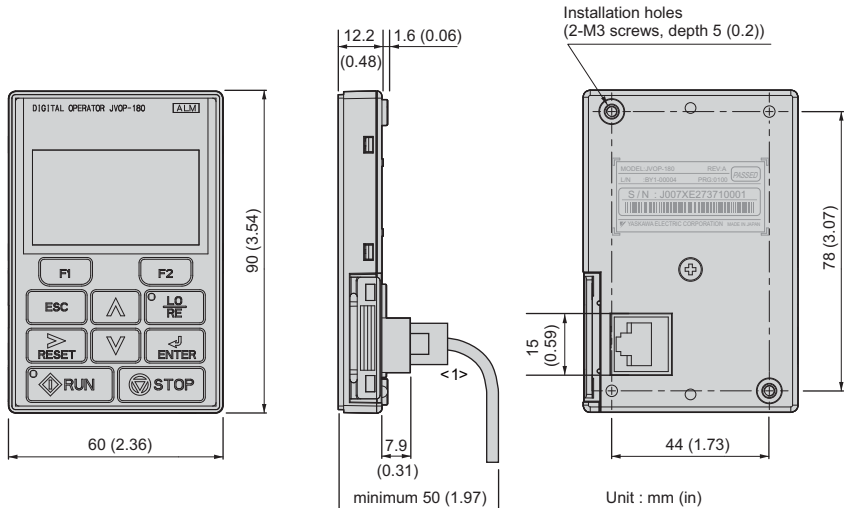

Figure 6 Dimensions

<1> Use only Yaskawa cables or cables recommended by Yaskawa. Refer to *Item Names and Part Numbers (Sold Separately)* on page 12.

◆ Installing the LCD Operator Option

There are two different installation methods for the LCD Operator Option depending on the application.

1. External/Face-mount: Mounted outside a panel.
2. Internal/Flush-mount: Mounted inside a panel.

Table 10 LCD Operator Option Installation Methods

Installation Method	Description	Notes
External/Face-mount	Simplified installation with the LCD Operator is mounted on the outside of the panel with two screws.	–
Internal/Flush-mount	Encloses the LCD Operator Option in the panel. The LCD Operator is flush with the outside of the panel.	Requires purchase of separate items. <i>Refer to Item Names and Part Numbers (Sold Separately)</i> on page 12.

5 Installation Procedure

External/Face-mount Installation

1. Cut an opening in the enclosure panel for the LCD Operator Option according to [Figure 8](#).
2. Position the LCD Operator Option so the LCD display faces outwards, and mount it to the enclosure panel as shown in [Figure 7](#).

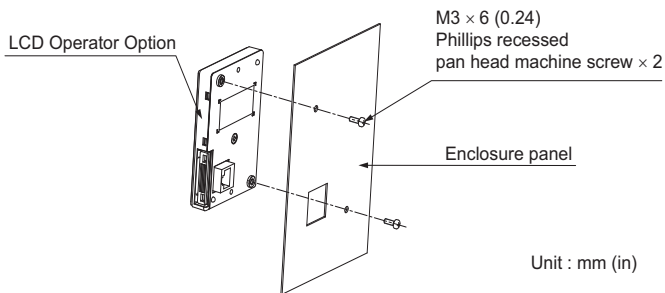

Figure 7 External/Face-mount Installation

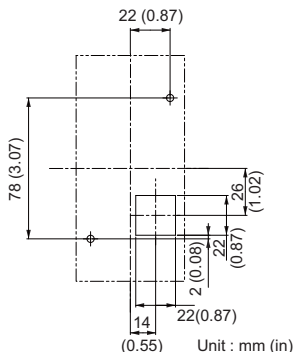

Figure 8 Panel Cut-out Dimensions (External/Face-mount Installation)

Internal/Flush-mount Installation

The internal flush-mount installation method requires an installation support that is purchased separately. *Refer to Item Names and Part Numbers (Sold Separately) on page 12* for information regarding the installation support and mounting hardware. *Figure 9* illustrates how to attach the Installation Support A.

1. Cut an opening in the enclosure panel for the LCD Operator Option according to *Figure 10*.
2. Mount the LCD Operator Option to the installation support (sold separately).
3. Mount the installation support and LCD Operator Option to the enclosure panel.

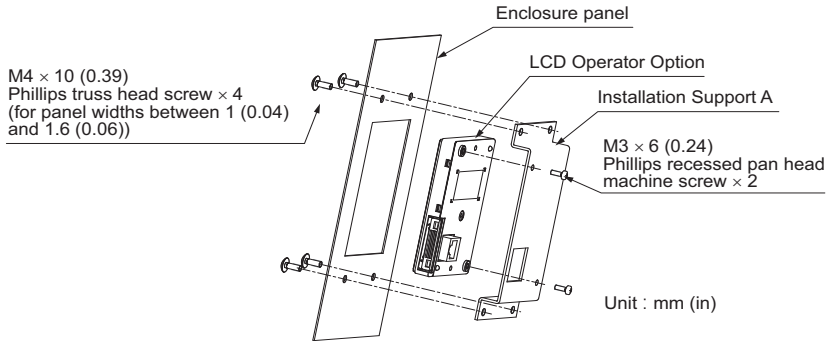

Figure 9 Internal/Flush Mount Installation

Note: For environments with a significant amount of dust or other airborne debris, use a gasket between the enclosure panel and the LCD Operator Option.

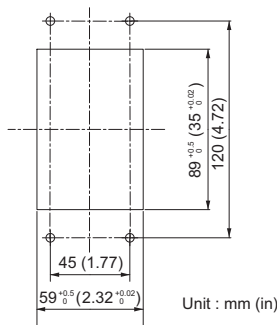

Figure 10 Panel Cut-out Dimensions (Internal/Flush-mount Installation)

5 Installation Procedure

◆ Connecting the LCD Operator Option to the Drive

This section contains instructions for connecting the LCD operator to V1000. For instructions on connecting the LCD operator to the other drives, see the Technical Manual of the drive connected to the LCD operator.

Plug the communication cable into the communication cable connector of the LCD Operator Option and the drive communications port as shown in **Figure 11**. Ensure both cable ends are firmly connected. **Refer to Item Names and Part Numbers (Sold Separately) on page 12** for information regarding recommended cables.

Refer to **Table 1** for Built-in LED Display Behavior with a Connected LCD Operator Option.

- Note:** Use only Yaskawa recommended cables. Using a cable not specified may cause the LCD Operator or drive to malfunction.
- Note:** The STOP key on the drives built-in LED operator is the only functional key on the built-in LED operator when the LCD Operator Option is connected to the drive and parameter b1-02 is set to 0 (LCD Operator Option). To disable the STOP key, set parameter o2-02 (STOP key Function Selection) to 0 (Disable).

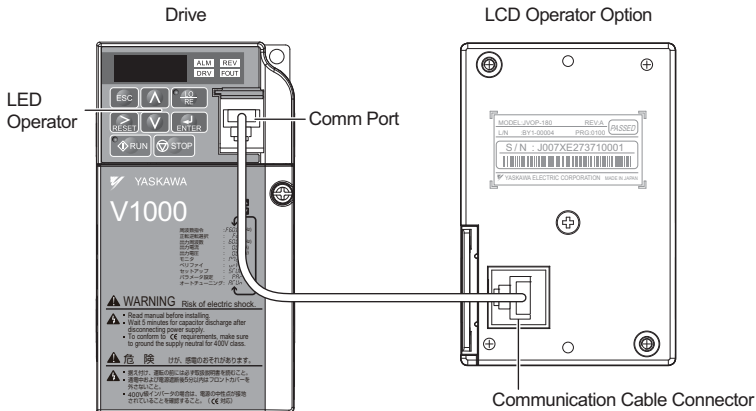

Figure 11 Communication Cable Connection

6 Basic Operation

◆ Menu Structure for LCD Operator Option

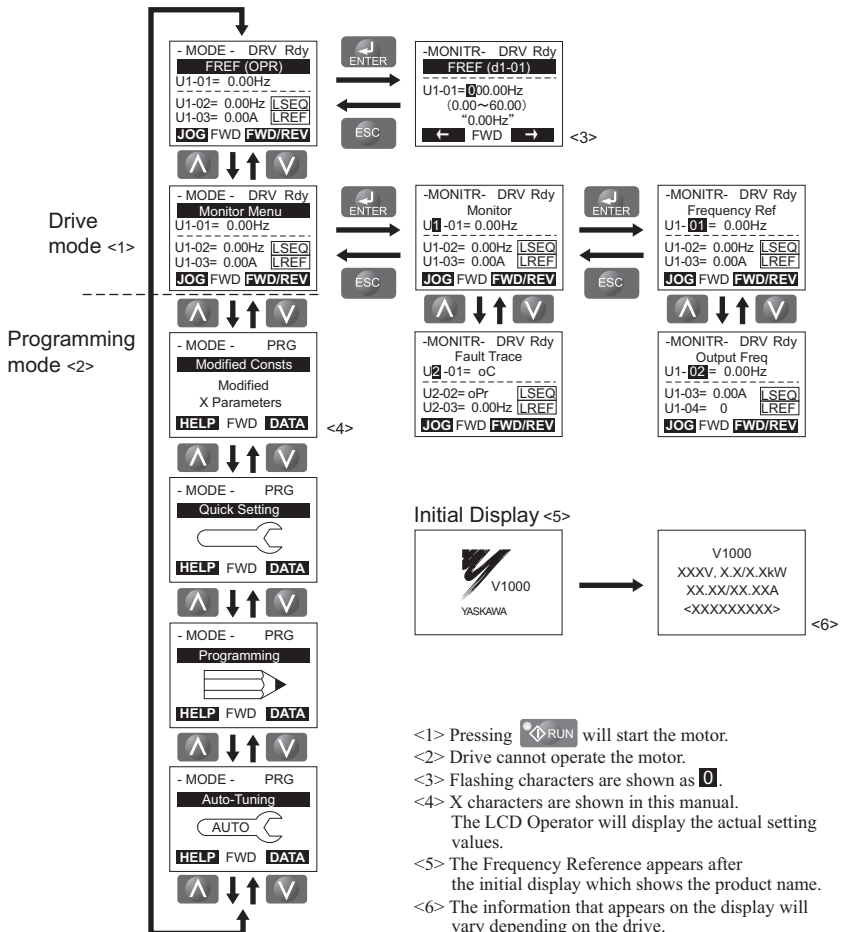

Figure 12 LCD Operator Option Menu Structure

6 Basic Operation







◆ Example: Basic Operation





The following procedures are examples of drive operation using the LCD Operator Option.

Note: Actual LCD display data can vary based on drive parameter settings.







■ Procedure Example: RUN/STOP

Note: If b1-01 is not set to 0 (Operator), press  to set LOCAL.

Procedure	LCD Display
<p>1. Apply main power to the drive. The Frequency Reference appears after the initial display on the LCD Operator Option.</p>	<pre> - MODE - DRV Rdy FREF (OPR) U1-01= 0.00Hz ----- U1-02= 0.00Hz LSEQ U1-03= 0.00A LREF JOG FWD FWD/REV </pre>
<p>2. Press  to show the Frequency Reference display.</p> <p>If b1-01 is not set to 0 (Operator), press  to set LOCAL.</p>	<pre> -MONITR- DRV Rdy FREF (d1-01) ----- U1-01= 000.00Hz (0.00~60.00) "0.00Hz" ← FWD → </pre>
<p>3. Press     until the frequency reference changes to 006.00 Hz.</p>	<pre> -MONITR- DRV Rdy FREF (d1-01) ----- U1-01= 006.00Hz (0.00~60.00) "0.00Hz" ← FWD → </pre>
<p>4. Press  to set the output frequency.</p>	<p style="text-align: center;">Entry Accepted</p>

<p>5. Press  to start the motor. The motor should accelerate up to 6 Hz while the RUN LED is on.</p>	<pre style="font-family: monospace; border: 1px solid black; padding: 5px;"> -MONITR- DRV Rdy FREF (d1-01) ----- U1-01= 006.00Hz (0.00~60.00) "0.00Hz"  FWD </pre>
<p>6. Press  to stop the motor. The RUN LED will flash until the motor comes to a complete stop.</p>	









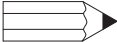

■ Procedure Example: Viewing Monitors

Procedure	LCD Screen
<p>1. Frequency Reference display.</p>	<pre style="font-family: monospace; border: 1px solid black; padding: 5px;"> - MODE - DRV Rdy FREF(OPR) U1-01= 0.00Hz ----- U1-02= 0.00Hz [LSEQ] U1-03= 0.00A [LREF] JOG FWD FWD/REV</pre>
<p>2. Press   until the Monitor Menu display appears.</p>	<pre style="font-family: monospace; border: 1px solid black; padding: 5px;"> - MODE - DRV Rdy Monitor Menu U1-01= 6.00Hz ----- U1-02= 0.00Hz [LSEQ] U1-03= 0.00A [LREF] JOG FWD FWD/REV</pre>
<p>3. Press  to show the Monitor display.</p>	<pre style="font-family: monospace; border: 1px solid black; padding: 5px;"> -MONITR- DRV Rdy Monitor U1-01= 6.00Hz ----- U1-02= 0.00Hz [LSEQ] U1-03= 0.00A [LREF] JOG FWD FWD/REV</pre>
<p>4. Press    to view the drive monitors.</p>	<pre style="font-family: monospace; border: 1px solid black; padding: 5px;"> -MONITR- DRV Rdy Last Fault U2-02= oPr ----- U2-03= 0.00Hz [LSEQ] U2-04= 0.00Hz [LREF] JOG FWD FWD/REV</pre>

6 Basic Operation

■ Procedure Example: Display Language Selection

The display language can be changed with parameter A1-00 (Select Language).









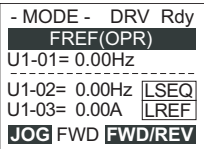

Procedure	LCD Screen
1. Frequency Reference.	<pre> - MODE - DRV Rdy FREF(OPR) U1-01= 0.00Hz ----- U1-02= 0.00Hz LSEQ U1-03= 0.00A LREF JOG FWD FWD/REV </pre>
2. Press   to select the Programming Mode.	<pre> -MODE- PRG Programming  HELP FWD DATA </pre>
3. Press  to show the Initialization display.	<pre> -PRMSET- PRG Initialization ----- A1-00= 0 Select Language ← FWD → </pre>
4. Press     to select A1-00 and press  .	<pre> -PRMSET- PRG Select Language ----- A1-00= 0 *0* English "1" ← FWD → </pre>
5. Press   to enter setting 1.	<pre> -PRMSET- PRG ゲンゴ (Language) ----- A1-00= 1 *0* ニホンゴ (Japanese) "1" ← FWD → </pre>

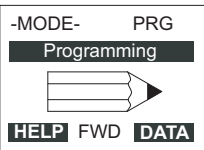
6. Press  and the LCD Operator Option will display Japanese.

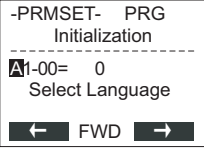



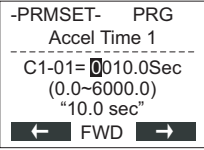

カキコミ カンリョウ

■ Procedure Example: Setting Parameters

The example below explains how to change the Deceleration Time parameter C1-01 to 20.0 from the default setting of 10.0 sec.

Procedure	LCD Screen
1. Frequency Reference display.	
2. Press   to select the Programming Mode.	
3. Press  to show the Initialization display.	
4. Press     to select parameter C1-01 and press  .	

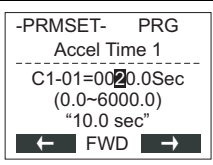
6 Basic Operation

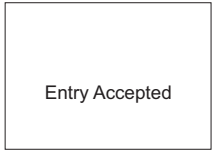
5. Press     to enter 20.0 sec.	
6. Press  to enter and store the new setting for C1-01.	

■ Read/Copy Function Procedure

Read

Reads and saves the parameter settings from the drive to the LCD Operator Option.

Note: The LCD Operator Option can perform the Read function an estimated 100,000 times.

Copy











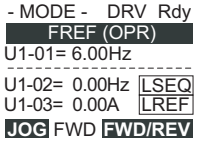

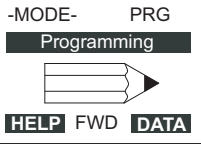
Copies the parameter settings from the LCD Operator Option to another Yaskawa drive.

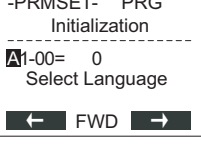
Verify

Verifies that parameter settings in the drive match the parameter settings saved to the LCD Operator Option.

The following procedure is used to read parameters from the drive.

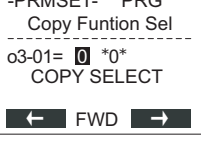
- Note:** Set parameter o3-02 (Read Allowable) to “1” (Enable) to read the parameter settings from the drive.
Set parameter o3-02 to “0” (disable) to protect the parameter settings in the LCD Operator Option.

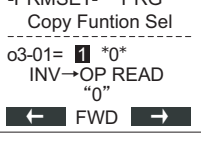
Procedure	LCD Screen
1. Frequency Reference display.	
2. Press   to select the Programming Mode.	
3. Press  to show the Initialization display.	
4. Press     to select o3-01 and press  .	
5. Press   to enter 1 (INV --> OP READ).	

6 Basic Operation

<p>6. Press  and the LCD Operator Option will read the parameter settings from the drive.</p>	<p>READ INV→OP READING</p>
<p>7. Automatically return to the Copy Function Selection display.</p>	<p>End READ COMPLETE</p>

7 Related Parameters

Parameters related to the use of the LCD Operator Option are listed below. Set these parameters as needed for the application.

Table 11 Related Parameters

No.	Name	Description	Default
A1-00	Language Selection	Language selection for the LCD Operator Option. This parameter is not reset when the drive is initialized by parameter A1-03. 0: English 1: Japanese 2: German 3: French 4: Italian 5: Spanish 6: Portuguese 7: Chinese	0
b1-01	Frequency Reference Selection 1	Selects the source of the frequency reference. 0: Operator -Digital preset speed d1-01 to d1-17 1: Terminals - Analog input terminal A1 or A2 2: MEMOBUS/Modbus serial communications 3: Option PCB 4: Pulse Input (Terminal RP)	1
b1-02	Run Command Selection 1	Selects the run command input source. 0: Operator -RUN and STOP keys on the LCD Operator Option 1: Digital input terminals S1 to S7 2: MEMOBUS/Modbus serial communications 3: Option PCB	1
b1-15	Frequency Reference 2	Selects the frequency reference input source. 0: Operator - Digital preset speed d1-01 to d1-17 1: Terminals - Analog input terminal A1 or A2 2: MEMOBUS/Modbus serial communications 3: Option PCB 4: Pulse Input (Terminal RP)	0
b1-16	Run Command Source 2	Selects the Run command input source. 0: Operator - RUN and STOP keys on the LCD Operator Option 1: Digital input terminals S1 to S7 2: MEMOBUS/Modbus serial communications 3: Option PCB	0
o2-01	LOCAL/REMOTE Key Function Selection	Enables/Disables the LCD Operator Option LOCAL/REMOTE key. 0: Disabled 1: Enabled	1

7 Related Parameters

No.	Name	Description	Default
o2-02	STOP Key Function Selection	Enables/Disables the operator panel STOP key when the drive is operated from external sources (not operator). 0: Disabled 1: Enabled	1
o2-05	Frequency Reference Setting Method Selection	Selects if the ENTER key press is required when inputting the frequency reference by the operator keypad. 0: Data/Enter key must be pressed to enter a frequency reference. 1: Data/Enter key is not required. The frequency reference is adjusted by the up and down arrow keys.	0
o2-06	Operation Selection when LCD Operator Option is Disconnected	Sets drive action when the LCD Operator Option is removed in LOCAL mode or with b1-02 = 0. 0: The drive will continue operation. 1: The drive will trigger a fault (oPr) and the motor will coast to stop.	0
o3-01	Copy Function Selection	This parameter controls the copying of parameters to and from the LCD Operator Option. 0: COPY SELECT (no function) 1: All parameters are copied from the drive to the LCD Operator Option. 2: All parameters are copied from the LCD Operator Option to the drive. 3: Parameter settings in the drive are compared to those in the LCD Operator Option. Note: When using the copy function, the drive model number (o2-04), software number (U1-14), and control method (A1-02) must match or an error will occur.	0
o3-02	Copy Allowable	Enables or disables reading of drive parameter settings. 0: Disabled - Read not allowed 1: Enabled - Read allowed	0

8 LCD Operator Option Fault Diagnostics

◆ Error Code and Connection Messages

Fault/Error code text will appear on the LCD Operator Option display to indicate a specific fault. The fault codes in **Table 12** are displayed on the LED operator and/or the LCD Operator Option displays. For information on the fault codes not listed in **Table 12**, refer to the drive technical manual.

When an LCD Operator Option fault occurs, ensure that the communication cable is properly connected to the LCD Operator Option and it is not loose.

Contact your nearest Yaskawa representative or sales department if the cable appears to be connect properly but still no message appears to indicate the error.

Table 12 Fault/Error Code Displays

LCD Operator	LED Operator	Description
</>	• • • • •	LCD Operator Option is connected This is not an error message.
	• • • • •	This is not an error message. Occurs when the LCD Operator Option is connected to the drive.
LCD Operator	LED Operator	Description
CPF00 COM-ERR(OP&INV)	</>	LCD Operator Option Communication Error 1
		Occurs when the drive cannot communicate with the LCD Operator Option within 5 seconds after the power is switched on.
Cause		Possible Solution
Communication cable between the LCD Operator Option and the drive is not properly connected.		Remove the LCD Operator Option and then reconnect it again.
Problem with the LCD Operator Option.		Replace the LCD Operator Option.
Problem with the control circuit in the drive.		<ul style="list-style-type: none"> • Cycle power to the drive. • Replace the drive.

8 LCD Operator Option Fault Diagnostics

LCD Operator	LED Operator	Description
CPF01 COM-ERR(OP&INV)	<>	LCD Operator Option Communication Error 2 Occurs if the drive does not respond to the LCD Operator Option for over 2 seconds.
Cause		Possible Solution
Connector on the LCD Operator Option cable is loose or damaged.		Remove the LCD Operator Option and then reconnect it again.
Problem with the LCD Operator Option.		Replace the LCD Operator Option.
Problem with the control circuit in the drive.		<ul style="list-style-type: none"> • Cycle power to the drive. • Replace the drive.
LCD Operator	LED Operator	Description
oPr Oper Disconnect	$\square \overset{\square}{r} r$	LCD Operator Option Connection Fault
	oPr	Data should appear on the LED operator. By reconnecting the LCD operator to the drive, data should also appear on the LCD Operator display. An oPr fault will occur if all of the following conditions are true: Output is interrupted when the LCD Operator Option is disconnected (o2-06 = 1). The run command is assigned to the LCD Operator Option (b1-02/b1-16= 0 and LOCAL is selected).
Cause		Possible Solution
LCD Operator Option is not properly connected to the drive.		<ul style="list-style-type: none"> • Check the connection between the LCD Operator Option and the drive. • Replace the cable if damaged. • Turn off the drive input power and disconnect the LCD Operator Option. Reconnect the LCD Operator Option and reapply drive input power.

<1> Display will vary depending on operation status.

9 Specifications

Table 13 LCD Operator Option Specifications

Model	JVOP-180
Connector	RJ-45
Power Supply	Powered from the drive (DC +5 V \pm 5%)
Operating Temperature	-10 to +50 °C <f>
Humidity	up to 95% RH (no condensation)
Storage Temperature	-20 to +60 °C (allowed for short-term transport of the product)
Area of Use	Indoor (free of corrosive gas, airborne particles, etc.)
Altitude	Up to 1000 m
Shock	10 to 20 Hz : 9.8 m/s ² 20 to 55 Hz : 5.9 m/s ²
Read Function Limitation	Estimated 100,000 times

<f> The LCD display may respond more slowly if the ambient temperature falls below freezing. Higher temperatures can also shorten the performance life of the LCD display.

10 Revision History

The revision dates and numbers of the revised manuals are given on the bottom of the back cover.

MANUAL NO. TOBP C730600 29A

Published in Japan June 2008 07-11 ◊
└─ Date of publication ─┘ └─ Revision number
└─ Date of original publication

Date of Published	Rev. No.	Section	Revised Content
November 2007	–	–	First edition
June 2008	◊ ₁	Back cover	Revision: Address
August 2008	◊ ₂	All Chapters	Revision: The title of the manual Revision: Application to the A1000 drive
December 2008	◊ ₃	Chapter 3	Revision: The part numbers of the additional parts.

YASKAWA AC Drive-Option LCD Operator Installation Manual

IRUMA BUSINESS CENTER (SOLUTION CENTER)

480, Kamifuji-sawa, Iruma, Saitama 358-8555, Japan
Phone 81-4-2962-5696 Fax 81-4-2962-6138

YASKAWA ELECTRIC AMERICA, INC.

2121 Norman Drive South, Waukegan, IL 60085, U.S.A.
Phone 1-847-887-7000 Fax 1-847-887-7370

YASKAWA ELÉTRICO DO BRASIL LTDA.

Avenida Fagundes Filho, 620 São Paulo-SP CEP 04304-000, Brazil
Phone 55-11-3585-1100 Fax 55-11-5581-8795

YASKAWA ELECTRIC EUROPE GmbH

Hauptstraße 185, 65760 Eschborn, Germany
Phone 49-6196-569-300 Fax 49-6196-569-398

YASKAWA ELECTRIC UK LTD.

1 Hunt Hill Orchardton Woods Cumbernauld, G68 9LF, United Kingdom
Phone 44-1236-735000 Fax 44-1236-458182

YASKAWA ELECTRIC KOREA CORPORATION

7F, Doore Bldg. 24, Yeoido-dong, Youngdungpo-Ku, Seoul 150-877, Korea
Phone 82-2-784-7844 Fax 82-2-784-8495

YASKAWA ELECTRIC (SINGAPORE) PTE. LTD.

151 Lorong Chuan, #04-01, New Tech Park 556741, Singapore
Phone 65-6282-3003 Fax 65-6289-3003

YASKAWA ELECTRIC (SHANGHAI) CO., LTD.

No.18 Xizang Zhong Road, Room 1702-1707, Harbour Ring Plaza Shanghai 200001, China
Phone 86-21-5385-2200 Fax 86-21-5385-3299

YASKAWA ELECTRIC (SHANGHAI) CO., LTD. BEIJING OFFICE

Room 1011A, Tower W3 Oriental Plaza, No.1 East Chang An Ave.,
Dong Cheng District, Beijing 100738, China
Phone 86-10-8518-4086 Fax 86-10-8518-4082

YASKAWA ELECTRIC TAIWAN CORPORATION

9F, 16, Nanking E. Rd., Sec. 3, Taipei, Taiwan
Phone 886-2-2502-5003 Fax 886-2-2505-1280



YASKAWA

YASKAWA ELECTRIC CORPORATION

In the event that the end user of this product is to be the military and said product is to be employed in any weapons systems or the manufacture thereof, the export will fall under the relevant regulations as stipulated in the Foreign Exchange and Foreign Trade Regulations. Therefore, be sure to follow all procedures and submit all relevant documentation according to any and all rules, regulations and laws that may apply. Specifications are subject to change without notice for ongoing product modifications and improvements.

© 2007-2008 YASKAWA ELECTRIC CORPORATION. All rights reserved.

MANUAL NO. TOBP C730600 29C

Published in Japan December 2008 07-11 -0
08-5-3