



YASKAWA

AC Servodrive

Σ -V Series

USER'S MANUAL

MECHATROLINK-II Command

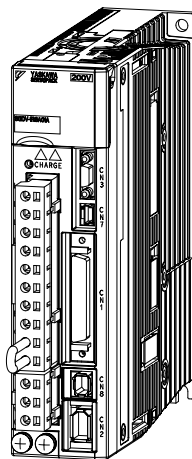

MECHATROLINK-II Commands	1
Operation Sequence	2
Commands for Preparation Process	3
Motion Commands for Operation	4
Command Related Parameters	5
MECHATROLINK-II Subcommands	6
Data Field	7
Appendix	App

Copyright © 2007 YASKAWA ELECTRIC CORPORATION

All rights reserved. No part of this publication may be reproduced, stored in a retrieval system, or transmitted, in any form, or by any means, mechanical, electronic, photocopying, recording, or otherwise, without the prior written permission of Yaskawa. No patent liability is assumed with respect to the use of the information contained herein. Moreover, because Yaskawa is constantly striving to improve its high-quality products, the information contained in this manual is subject to change without notice. Every precaution has been taken in the preparation of this manual. Nevertheless, Yaskawa assumes no responsibility for errors or omissions. Neither is any liability assumed for damages resulting from the use of the information contained in this publication.

Preface

This manual describes the specifications of MECHATROLINK-II commands used for Σ -V series SERVOPACKs model SGD \square V- $\square\square\square\square$ 11 and 15 (MECHATROLINK-II communications reference input type), the basic operations using these commands, and the parameters for these commands.

This manual is designed to provide information for:

- People who implement MECHATROLINK-II commands for a controller
- People who prepare the application program for the host controller that directly transmits MECHATROLINK-II commands

Refer to the following manuals for information on Σ -V series SERVOPACKs, including hardware, adjustment methods, and trial operation.

- Σ -V Series SGM \square V/SGDV Catalog (KAEPS80000042)
- Σ -V Series SGM \square V/SGDV User's Manual Setup Rotational Motor (SIEPS80000043)
- Σ -V Series SGM \square V/SGDV User's Manual Setup Linear Motor (SIEPS80000044)
- Σ -V Series SGM \square V/SGDV User's Manual Design and Maintenance Rotational Motor/MECHATROLINK-II Communications Reference (SIEPS80000046)
- Σ -V Series SGM \square V/SGDV User's Manual Design and Maintenance Linear Motor/MECHATROLINK-II Communications Reference (SIEPS80000048)



IMPORTANT

- Be sure that you fully understand each command and use the commands in the order appropriate for your application.
Incorrect usage of the commands can result not only unexpected motions, but in a serious accident.
Special care and verification must be taken for usage of the commands in order to avoid accidents.
Be sure to also establish safety measures for the system.

CONTENTS

Preface	iii
Chapter 1 MECHATROLINK-II Commands	1-1
1.1 MECHATROLINK-II Communications	1-2
1.1.1 Layers	1-2
1.1.2 Frame Structure	1-2
1.1.3 State Transition Diagram	1-3
1.1.4 Terminology	1-4
1.2 MECHATROLINK-II Command List	1-5
1.2.1 Main Commands (In command code order)	1-5
1.2.2 Subcommands (In command code order)	1-6
1.2.3 Combination of MECHATROLINK-II Main Commands and Subcommands	1-7
1.3 Command and Response Timing	1-8
1.3.1 Command Data Execution Timing	1-8
1.3.2 Monitored Data Input Timing	1-8
1.4 Data Order	1-9
Chapter 2 Operation Sequence	2-1
2.1 Preparing for Operation	2-2
2.1.1 Setting MECHATROLINK-II Communications	2-2
2.1.2 Checking the Communications Status	2-2
2.2 Operation Sequence for Managing Parameters Using a Controller	2-3
2.3 Operation Sequence for Managing Parameters Using a SERVOPACK	2-4
2.3.1 Setup Sequence	2-4
2.3.2 Ordinary Operation Sequence	2-4
2.4 Specific Operation Sequences	2-5
2.4.1 Operation Sequence When Turning the Servo ON	2-5
2.4.2 Operation Sequence When OT (Overtravel Limit Switch) Signal Is Input	2-5
2.4.3 Operation Sequence at Emergency Stop (Main Circuit OFF)	2-5
2.4.4 Operation Sequence When a Safety Signal is Input	2-6
2.4.5 Operation Sequence At Occurrence of Alarm	2-6
2.5 Setting the Origin Before Starting Operation	2-8
2.5.1 When Using an Incremental Encoder	2-8
2.5.2 When Using an Absolute Encoder	2-8
Chapter 3 Commands for Preparation Process	3-1
3.1 No Operation (NOP: 00H)	3-3
3.2 Release MECHATROLINK-II Connection (DISCONNECT: 0FH)	3-6
3.3 Establish MECHATROLINK-II Connection (CONNECT: 0EH)	3-7
3.4 Start Synchronous Communications (SYNC_SET: 0DH)	3-9
3.5 Check Device ID (ID_RD: 03H)	3-10
3.6 Set Parameters (PRM_WR: 02H)	3-12
3.7 Set and Save Parameters in Non-volatile Memory (PPRM_WR: 1CH)	3-13
3.8 Validate Parameters (Setup) (CONFIG: 04H)	3-14
3.9 Turn Encoder Power Supply ON (SENS_ON: 23H)	3-15
3.10 Turn Servo ON (SV_ON: 31H)	3-18
3.11 Turn Encoder Power Supply OFF (SENS_OFF: 24H)	3-20

3.12 Turn Servo OFF (SV_OFF: 32H)	3-21
3.13 Read Parameters (PRM_RD: 01H)	3-22
3.14 Check SERVOPACK Status (SMON: 30H)	3-23
3.15 Read Alarm or Warning (ALM_RD: 05H)	3-24
3.16 Clear Warning or Alarm (ALM_CLR: 06H)	3-26
3.17 Set Coordinate System (POS_SET: 20H)	3-27
3.18 Monitor and Adjust Settings (ADJ: 3EH)	3-28

Chapter 4 Motion Commands for Operation 4-1

4.1 Stop Motion (HOLD: 25H)	4-3
4.2 Set Latch Mode (LTMOD_ON: 28H)	4-5
4.3 Release Latch Mode (LTMOD_OFF: 29H)	4-8
4.4 Interpolation Feeding (INTERPOLATE: 34H)	4-9
4.5 Positioning (POSING: 35H)	4-11
4.6 Constant Speed Feeding (FEED: 36H)	4-13
4.7 Interpolation Feeding with Position Detection (LATCH: 38H)	4-15
4.8 External Input Positioning (EX_POSING: 39H)	4-17
4.9 Homing (ZRET: 3AH)	4-19
4.10 Velocity Control (VELCTRL: 3CH)	4-21
4.11 Torque (Force) Control (TRQCTRL: 3DH)	4-23

Chapter 5 Command Related Parameters 5-1

5.1 Electronic Gear Setting	5-4
5.1.1 Electronic Gear	5-4
5.1.2 Setting the Electronic Gear Ratio	5-4
5.2 Motion Acceleration/Deceleration Function Setting	5-5
5.2.1 Linear Acceleration/Deceleration Function	5-5
5.2.2 Position Reference Filter	5-6
5.2.3 Linear Deceleration Speed Setting for Commands to Stop a Motor	5-7
5.3 Motion Sequence Setting	5-9
5.3.1 Settings for EX_POSING Command	5-9
5.3.2 Settings for ZRET Command	5-9
5.4 Command Data Options	5-10
5.4.1 Torque (Force) Limiting Function	5-10
5.4.2 Torque (Force) Feed Forward Function	5-11
5.4.3 Speed Limiting Function During Torque (Force) Control	5-11
5.4.4 OPTION Field Allocation	5-12
5.5 Position Data Latch Function Setting	5-14
5.5.1 Latching Allowable Area	5-14
5.5.2 Continuous Latch Function	5-14
5.6 Acceleration/Deceleration Parameter High-speed Switching Function	5-17
5.7 STATUS Field and Monitor Related Settings	5-20
5.7.1 STATUS Field Status Detection Level Setting	5-20
5.7.2 I/O Monitor Field Signal Allocation	5-22
5.7.3 Option Monitor Setting	5-23

Chapter 6 MECHATROLINK-II Subcommands 6-1

6.1 No Operation (NOP: 00H)	6-2
6.2 Read Parameter (PRM_RD: 01H)	6-2
6.3 Write Parameter (PRM_WR: 02H)	6-3

6.4 Read Alarm or Warning (ALM_RD: 05H)	6-3
6.5 Write Non-volatile Parameter (PPRM_WR: 1CH)	6-4
6.6 Set Latch Mode (LTMOD_ON: 28H).	6-4
6.7 Release Latch Mode (LTMOD_OFF: 29H).	6-5
6.8 Status Monitoring (SMON: 30H).	6-5

Chapter 7 Data Field	7-1
--------------------------------	-----

Appendix	A-1
--------------------	-----

A Brake Control Commands.	A-2
B General-purpose Servo Control Command	A-4
C Latch Function	A-6

Revision History	
------------------	--

MECHATROLINK-II Commands

This chapter provides an outline of MECHATROLINK-II commands.

1.1	MECHATROLINK-II Communications	1-2
1.1.1	Layers	1-2
1.1.2	Frame Structure	1-2
1.1.3	State Transition Diagram	1-3
1.1.4	Terminology	1-4
1.2	MECHATROLINK-II Command List	1-5
1.2.1	Main Commands (In command code order)	1-5
1.2.2	Subcommands (In command code order)	1-6
1.2.3	Combination of MECHATROLINK-II Main Commands and Subcommands	1-7
1.3	Command and Response Timing	1-8
1.3.1	Command Data Execution Timing	1-8
1.3.2	Monitored Data Input Timing	1-8
1.4	Data Order	1-9

1.1 MECHATROLINK-II Communications

1.1.1 Layers

The MECHATROLINK-II communications layers have functions equivalent to layers 1, 2, and 7 in the OSI (Open System Interconnection) reference model.

OSI Reference Model and MECHATROLINK-II Model

OSI	MECHATROLINK-II
Layer 7: Application layer	MECHATROLINK-II application layer
Layers 3 to 6	None
Layer 2: Data link layer	MECHATROLINK-II data link layer
Layer 1: Physical layer	MECHATROLINK-II physical layer

This manual describes commands for the application layer.

1.1.2 Frame Structure

A MECHATROLINK-II command is composed of a main command and a subcommand as shown below. It can also be used only with a main command.

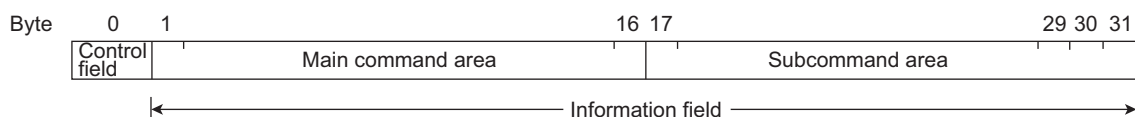

Classification	Byte	Command	Response
Control Field	0	03H (Fixed)	01H (Fixed)
Information Field	1 to 16	Used by main command.	
	17 to 31	Used by subcommands. The subcommands for servo drives use only 17th to 29th byte. Therefore, only 17th to 29th byte are described in this manual. Note: In some main commands, subcommand cannot be used.	

The application layer interfaces with only the information field.

1.1.3 State Transition Diagram

The primary (master) and secondary (slave) station state transitions are shown in the following diagrams.

Primary Station (Master Station) State Transition

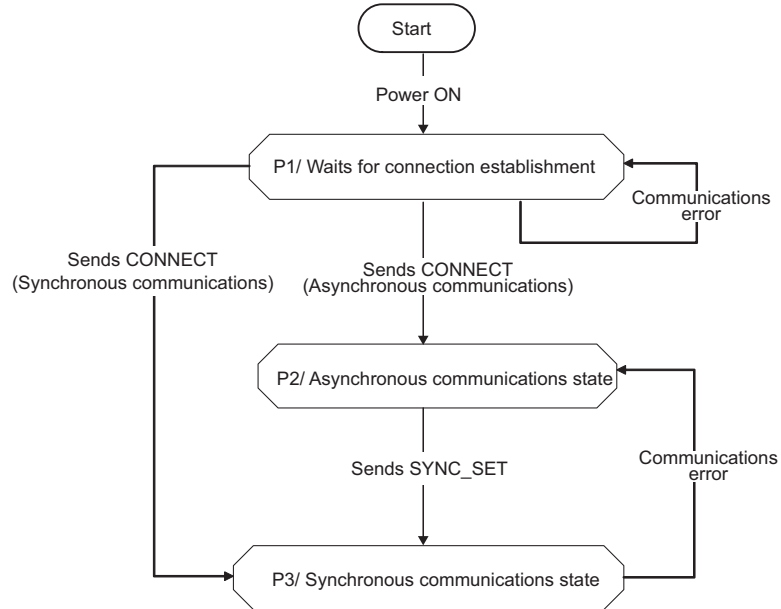

Secondary Station (Slave Station) State Transition

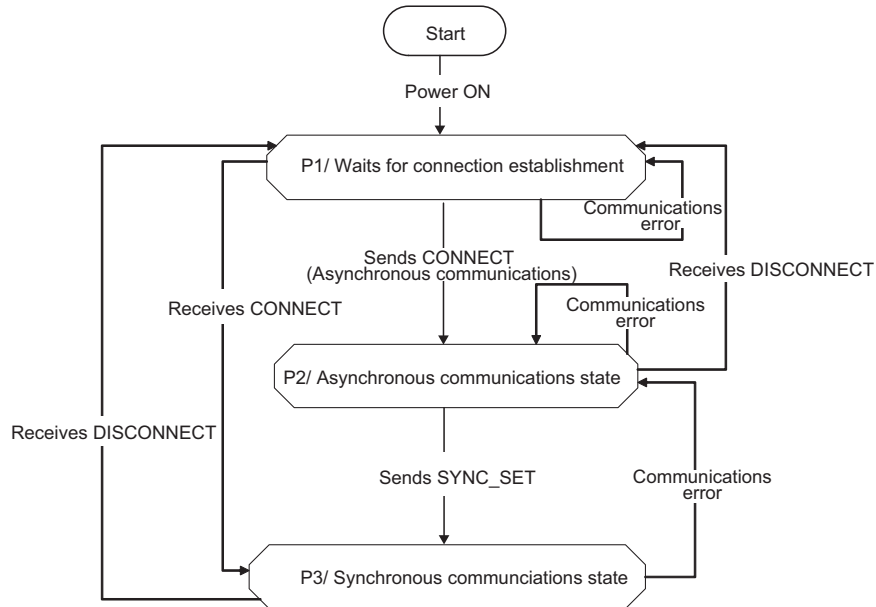

Phase	Abbreviation	Description
1	P1	Waiting for establishment of connection.
2	P2	Asynchronous communications enabled. Only asynchronous commands can be used.
3	P3	Synchronous communications enabled. Both synchronous and asynchronous commands can be used.

1.1.4 Terminology

This section defines the terminology used in this manual.

(1) Transmission Cycle and Communications Cycle

■ Transmission Cycle:

The transmission cycle is the cycle in the MAC (Media Access Control) layer. It is the communications cycle for physically sending data to the transmission path.

The transmission cycle is unaffected by the services provided by the application layer.

■ Communications Cycle:

The communications cycle is the cycle for application layer. The communications cycle is set to an integral multiple of the transmission cycle.

(2) Synchronization Classification

MECHATROLINK-II commands include both synchronous and asynchronous commands.

• Synchronous Commands (Classification S):

For commands of this type, commands are sent and response are received every communications cycle.

A response to a command that has been sent to a slave station is received at the next communications cycle.

The WDT (Watchdog Timer) in the frames are refreshed and checked every communications cycle. Synchronous commands can be used only during synchronous communications (Phase 3).

• Asynchronous Commands (Classification A):

For commands of this type, commands are sent asynchronously to the communications cycle.

Subsequent commands can be sent after confirming the completion of processing of the slave station that received the command.

The WDT (Watchdog Timer) in the frames are not checked.

1.2 MECHATROLINK-II Command List

1.2.1 Main Commands (In command code order)

The MECHATROLINK-II main commands used for Σ -V series servodrives are listed below.

Command Code	Command	Function	Reference
00H	NOP	Nothing is performed.	3.1
01H	PRM_RD	Reads the specified parameter.	3.13
02H	PRM_WR	Saves the specified parameter.	3.6
03H	ID_RD	Reads the device ID.	3.5
04H	CONFIG	Enables the current parameter settings.	3.8
05H	ALM_RD	Reads the current alarm or warning status, and the alarm history.	3.15
06H	ALM_CLR	Clears the current alarm or warning status, and the alarm history.	3.16
0DH	SYNC_SET	Starts synchronous communications.	3.4
0EH	CONNECT	Requests to establish a MECHATROLINK connection.	3.3
0FH	DISCONNECT	Requests to releases connection.	3.2
1CH	PPRM_WR	Saves the parameters in non-volatile memory.	3.7
20H	POS_SET	Sets the coordinates.	3.17
23H	SENS_ON	Turns the encoder power supply on, and gets the position data.	3.9
24H	SENS_OFF	Turns the encoder power supply off.	3.11
25H	HOLD	From current motion status, performs a deceleration stop and positioning according to the deceleration value set in the parameter.	4.1
28H	LTMOD_ON	Enables the position data latch by the external signal input.	4.2
29H	LTMOD_OFF	Disables the position data latch by the external signal input.	4.3
30H	SMON	Monitors the SERVOPACK status.	3.14
31H	SV_ON	Turns the servo of the motor on.	3.10
32H	SV_OFF	Turns the servo of the motor off.	3.12
34H	INTERPOLATE	Starts interpolation feeding.	4.4
35H	POSING	Starts positioning to the target position (TPOS) at the target speed (TSPD).	4.5
36H	FEED	Starts constant speed feeding at the target speed (TSPD)	4.6
38H	LATCH	Performs interpolation feeding and latches the position using the specified latch signal.	4.7
39H	EX_POSING	Moves toward the target position (TPOS) at the target speed (TSPD). When a latch signal is input midway, positioning is performed according to the final travel distance for external position specified in the parameter from the latch signal input position.	4.8
3AH	ZRET	Performs a homing.	4.9
3CH	VELCTRL	Controls speed.	4.10
3DH	TRQCTRL	Controls torque (force).	4.11
3EH	ADJ	Used to monitor and adjust data for maintenance.	3.18

1.2.2 Subcommands (In command code order)

The MECHATROLINK-II subcommands used for Σ -V series servodrives are listed below.

Command Code	Command	Function	Reference
00H	NOP	Same function as of the main command NOP	6.1
01H	PRM_RD	Same function as of the main command PRM_RD	6.2
02H	PRM_WR	Same function as of the main command PRM_WR	6.3
05H	ALM_RD	Same function as of the main command ALM_RD	6.4
1CH	PPRM_WR	Same function as of the main command PPRM_WR	6.5
28H	LTMOD_ON	Same function as of the main command LTMOD_ON	6.6
29H	LTMOD_OFF	Same function as of the main command LTMOD_OFF	6.7
30H	SMON	Same function as of the main command SMON	6.8

1.2.3 Combination of MECHATROLINK-II Main Commands and Subcommands

Subcommands can be used by combining as listed below.

CODE	Maine Command	Subcommand						
		NOP	PRM_WR	ALM_RD	PPRM_WR	LTMOD_ON	LTMOD_OFF	SMON
00	NOP	OK	OK	OK	OK	OK	OK	OK
01	PRM_RD	OK	NG	NG	NG	NG	NG	OK
02	PRM_WR	OK	NG	NG	NG	NG	NG	OK
03	ID_RD	OK	OK	OK	OK	OK	OK	OK
04	CONFIG	OK	NG	NG	NG	NG	NG	OK
05	ALM_RD	OK	NG	NG	NG	NG	NG	OK
06	ALM_CLR	OK	NG	NG	NG	NG	NG	OK
0D	SYNC_SET	OK	NG	NG	NG	NG	NG	OK
0E	CONNECT	OK	NG	NG	NG	NG	NG	NG
0F	DISCONNECT	OK	NG	NG	NG	NG	NG	NG
1C	PPRM_WR	OK	NG	NG	NG	NG	NG	OK
20	POS_SET	OK	NG	NG	NG	NG	NG	OK
23	SENS_ON	OK	NG	NG	NG	NG	NG	OK
24	SENS_OFF	OK	NG	NG	NG	NG	NG	OK
25	HOLD	OK	OK	OK	OK	OK	OK	OK
28	LTMOD_ON	OK	NG	NG	NG	NG	NG	OK
29	LTMOD_OFF	OK	NG	NG	NG	NG	NG	OK
30	SMON	OK	OK	OK	OK	OK	OK	OK
31	SV_ON	OK	OK	OK	OK	OK	OK	OK
32	SV_OFF	OK	OK	OK	OK	OK	OK	OK
34	INTERPOLATE	OK	OK	OK	OK	OK	OK	OK
35	POSING	OK	OK	OK	OK	OK	OK	OK
36	FEED	OK	OK	OK	OK	OK	OK	OK
38	LATCH	OK	OK	OK	OK	NG	NG	OK
39	EX_POSING	OK	OK	OK	OK	NG	NG	OK
3A	ZRET	OK	OK	OK	OK	NG	NG	OK
3C	VELCTRL	OK	OK	OK	OK	OK	OK	OK
3D	TRQCTRL	OK	OK	OK	OK	OK	OK	OK
3E	ADJ	OK	NG	NG	NG	NG	NG	OK

Note: OK: Can be combined, NG: Cannot be combined

1.3 Command and Response Timing

This section describes command execution timing at a slave station and monitored data input timing at the master station.

These timings are constant, regardless of the transmission cycle and communications cycle.

1.3.1 Command Data Execution Timing

Motion commands (such as POSING and INTERPOLATE) and the OPTION in the command data field are executed 312.5 μ s after they are received.

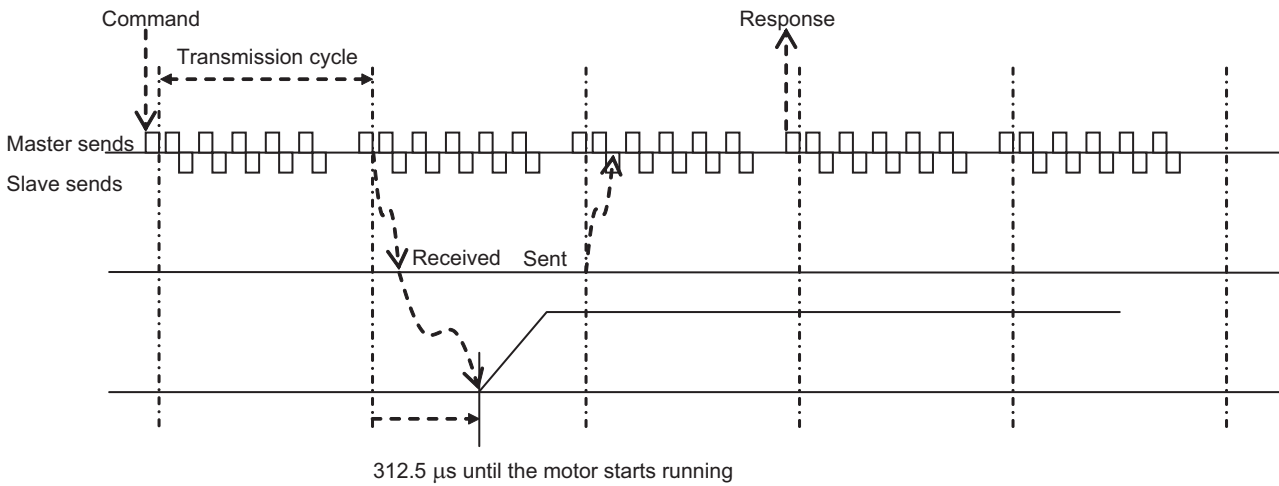

1.3.2 Monitored Data Input Timing

The monitor, I/O, and status data are the data of 312.5 μ s before the response is sent.

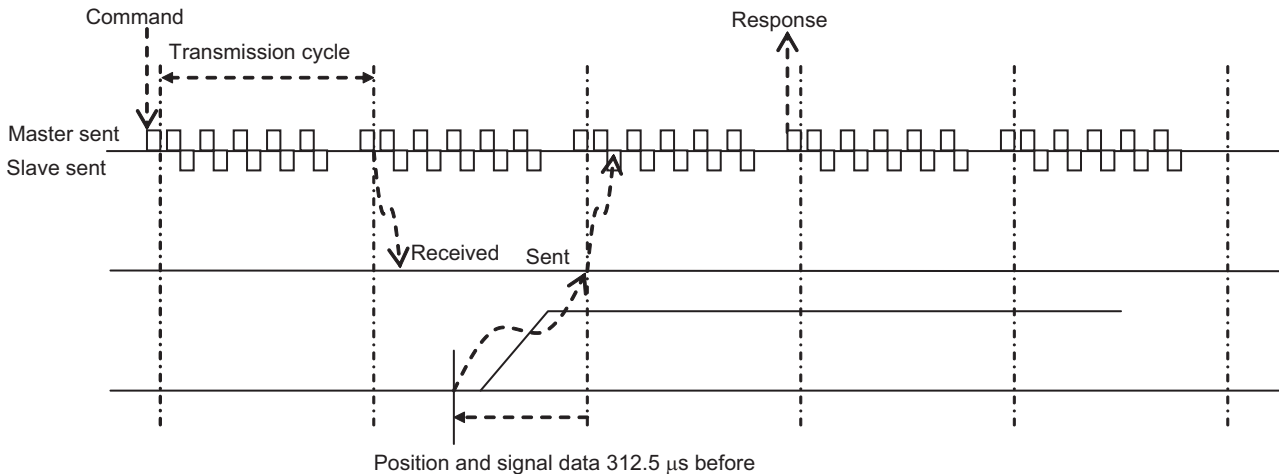

1.4 Data Order

Data in MECHATROLINK-II commands and responses is stored in little endian byte order. For example, 4-byte data “0x1234ABCD” in hexadecimal is stored from the least significant byte as shown below.

Byte	Data
1	CD
2	AB
3	34
4	12

Operation Sequence

This chapter describes basic operation sequences through MECHATROLINK-II communications.

2.1	Preparing for Operation	2-2
2.1.1	Setting MECHATROLINK-II Communications	2-2
2.1.2	Checking the Communications Status	2-2
2.2	Operation Sequence for Managing Parameters Using a Controller	2-3
2.3	Operation Sequence for Managing Parameters Using a SERVOPACK	2-4
2.3.1	Setup Sequence	2-4
2.3.2	Ordinary Operation Sequence	2-4
2.4	Specific Operation Sequences	2-5
2.4.1	Operation Sequence When Turning the Servo ON	2-5
2.4.2	Operation Sequence When OT (Overtravel Limit Switch) Signal Is Input	2-5
2.4.3	Operation Sequence at Emergency Stop (Main Circuit OFF)	2-5
2.4.4	Operation Sequence When a Safety Signal is Input	2-6
2.4.5	Operation Sequence At Occurrence of Alarm	2-6
2.5	Setting the Origin Before Starting Operation	2-8
2.5.1	When Using an Incremental Encoder	2-8
2.5.2	When Using an Absolute Encoder	2-8

2.1 Preparing for Operation

This section describes how to set communications specifications before starting communications, and how to confirm the communications status.

2.1.1 Setting MECHATROLINK-II Communications

The rotary switch (SW1) and DIP switch (SW2), which are located near the top under the front cover of Σ -V series SERVOPACK, are used as shown below to set the MECHATROLINK-II communications specifications.

SW1 is used to set the lowermost digit of station address. SW2 is used to set the communications specifications as shown in the table below.

SW2	Function	Setting	Description	Factory setting
Pin 1	Sets the baud rate.	OFF	4 Mbps (MECHATROLINK-I)	ON
		ON	10 Mbps (MECHATROLINK-II)	
Pin 2	Sets the number of transmission bytes.	OFF	17 bytes	ON
		ON	32 bytes	
Pin 3	Sets the station address.	OFF	Station address = 40H+SW1	OFF
		ON	Station address = 50H+SW1	
Pin 4	Reserved. (Do not change.)	OFF	—	OFF

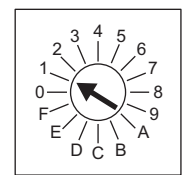

SW1(factory setting)

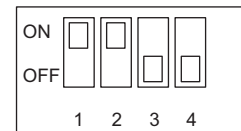

SW2(factory settings)

2.1.2 Checking the Communications Status

Turn ON the control and main circuit power supplies and use the following procedure to confirm that the SERVOPACK is ready for communications.

(1) Operation Procedure

Procedure	Operation
1	Confirm that the wiring is correctly made.
2	Turn ON the SERVOPACK control and main circuit power supplies. When the control power is being normally supplied to the SERVOPACK, POWER LED on the SERVOPACK is lit. When the main circuit power supply is ON, CHARGE is lit.
3	Turn ON the controller power supply and start MECHATROLINK communications.
4	Check the communications status. When communications in the data link layer have started, COM LED on the SERVOPACK is lit. Note: If COM LED is not lit, check the communications settings of SW1, SW2, and the controller, and then turn the power supplies OFF and ON again. When the MECHATROLINK-II connection in the application layer is established, the 7-segment LED indicates the completion of CONNECT execution as shown below.



When lit: CONNECT execution completed
When unlit: CONNECT execution not completed

2.2 Operation Sequence for Managing Parameters Using a Controller

When the parameters are managed by a controller, the parameters are automatically transmitted from the controller to the SERVOPACK when the power is turned ON. Therefore, the settings of SERVOPACK do not need to be changed when the SERVOPACK is replaced.

Procedure	Operation	Command to Send
1	Turn on the control and main circuit power supplies.	NOP
2	Reset the previous communications status.	DISCONNECT*
3	Establish communications connection and starts WDT count.	CONNECT
4	Check information such as device ID.	ID_RD
5	Get device setting data such as parameters.	PRM_RD, ADJ
6	Set the parameters required for device.	PRM_WR
7	Enable the parameter settings (Setup).	CONFIG
8	Turn the encoder power supply to the position data.	SENS_ON
9	Turn the servo on.	SV_ON
10	Start operation.	
11	Turn the servo off.	SV_OFF
12	Disconnect the communications connection.	DISCONNECT
13	Turn the control and main circuit power supplies.	–

* If the connection cannot be released normally, send DISCONNECT command for 2 or more communications cycles, and then send CONNECT command.

2.3 Operation Sequence for Managing Parameters Using a SERVOPACK

To manage the parameters by using SERVOPACK's non-volatile memory, save the parameters in the non-volatile memory at setup and use an ordinary operation sequence.

2.3.1 Setup Sequence

Procedure	Operation	Command to Send
1	Turn on the control and main circuit power supply.	NOP
2	Reset the previous communications status.	DISCONNECT*
3	Establish communications connection and start WDT count.	CONNECT
4	Check information such as device ID.	ID_RD
5	Get device setting data such as parameters.	PRM_RD, ADJ
6	Save the parameters required for device in the non-volatile memory.	PPRM_WR Note: Do not use PRM_WR.
7	Disconnect the communications connection.	DISCONNECT
8	Turn off the control and main circuit power supplies.	—

* If the connection cannot be released normally, send a DISCONNECT command for 2 or more communications cycles, and then send a CONNECT command.

2.3.2 Ordinary Operation Sequence

Procedure	Operation	Command to Send
1	Turn on the control and main circuit power supplies.	NOP
2	Reset the previous communications status.	DISCONNECT*
3	Establish communications connection and start WDT count.	CONNECT
4	Check information such as device ID.	ID_RD
5	Get device setting data such as parameters.	PRM_RD, ADJ
6	Turn on the encoder power supply to get the position data.	SENS_ON
7	Turn the servo on.	SV_ON
8	Start operation.	POSING, INTERPOLATE, etc.
9	Turn the servo off.	SV_OFF
10	Disconnect the communications connection.	DISCONNECT
11	Turn off the control and main circuit power supplies.	—

* If the connection cannot be released normally, send a DISCONNECT command for 2 or more communications cycles, and then send a CONNECT command.

2.4 Specific Operation Sequences

This section describes operations that use commands in specific sequences.

2.4.1 Operation Sequence When Turning the Servo ON

Motor control using a host controller is performed using motion commands only during Servo ON (motor power ON).

While the SERVOPACK is in Servo OFF status (while current to the motor is interrupted), the SERVOPACK manages position data so that the reference coordinate system (POS, MPOS) and the feedback coordinate system (APOS) are equal. For correct execution of motion commands, therefore, it is necessary to use the SMON (Status Monitoring) command after the SERVOPACK status changes to Servo ON, to read the servo reference coordinates (POS) and send an appropriate reference position.

Confirm the following bit status before sending the SV_ON command:

STATUS field: PON = 1 and ALM = 0

IO Monitor field: HBB = 0

2.4.2 Operation Sequence When OT (Overtravel Limit Switch) Signal Is Input

When an OT signal is input, the SERVOPACK prohibits the motor from rotating in the way specified in the parameter Pn001. The motor continues to be controlled by the SERVOPACK while its rotation is prohibited.

When an OT signal is input, use the following procedure to process the OT signal.

Procedure	Operation
1	Monitor OT signals (P_OT and N_OT of IO Monitor field). When an OT signal is input, send an appropriate stop command: While an interpolation command (INTERPOLATE, LATCH) is being executed: Leave the interpolation command as it is and stop updating the interpolation position. Or, send a HOLD command and SMON command. While a move command (such as POSING) other than interpolation commands is being executed: Send a HOLD command.
2	Check the output completion flag DEN. If DEN = 1, the SERVOPACK completed the OT processing. At the same time, check the flag PSET. If PSET = 1, the motor is completely stopped. Keep the command used in procedure 1 active until both of the above flags are set to 1.
3	Use a move command such as POSING for OT cancellation (retraction) processing. Before sending a move command, read out the current reference position (POS) and write it to reset the correct reference coordinate system for the controller.

Information: When an OT signal is input during execution of motion command ZRET or EX_POSING, the execution of the command will be cancelled. For retraction, always send a stop command described in procedure 1 first, and then send a retraction command (move command).

2.4.3 Operation Sequence at Emergency Stop (Main Circuit OFF)

After confirming that SV_ON or PON bit in the response data STATUS field is OFF (= 0), send an SV_OFF command.

During emergency stop, always monitor the SERVOPACK status using a command such as the SMON (Status Monitoring) command.

2.4.4 Operation Sequence When a Safety Signal is Input

When an HWBB1 or HWBB2 signal is input while the motor is being operated, current to the motor will be forcibly stopped, and the motor will be stopped according to the setting of the 1st digit of parameter Pn001.

[When an HWBB signal is input after the SERVOPACK stops powering the motor]

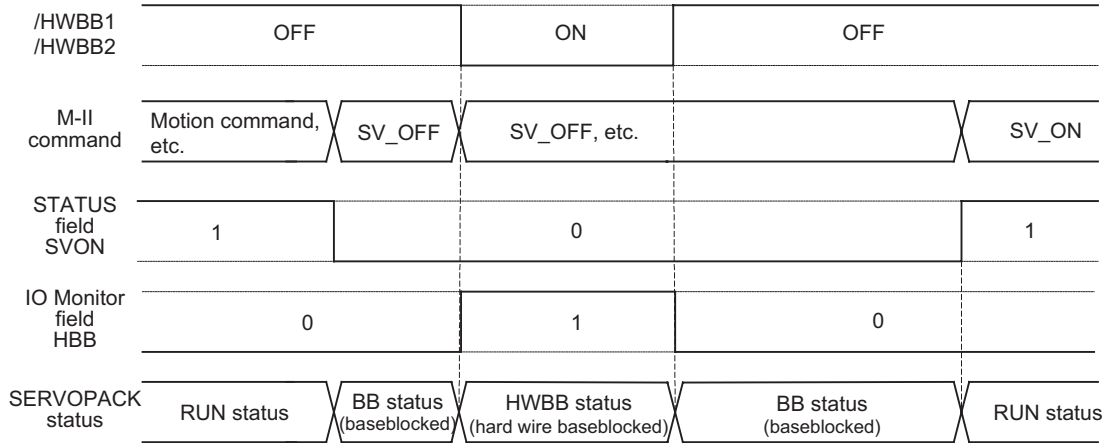

[When an HWBB signal is input while the SERVOPACK is powering the motor]

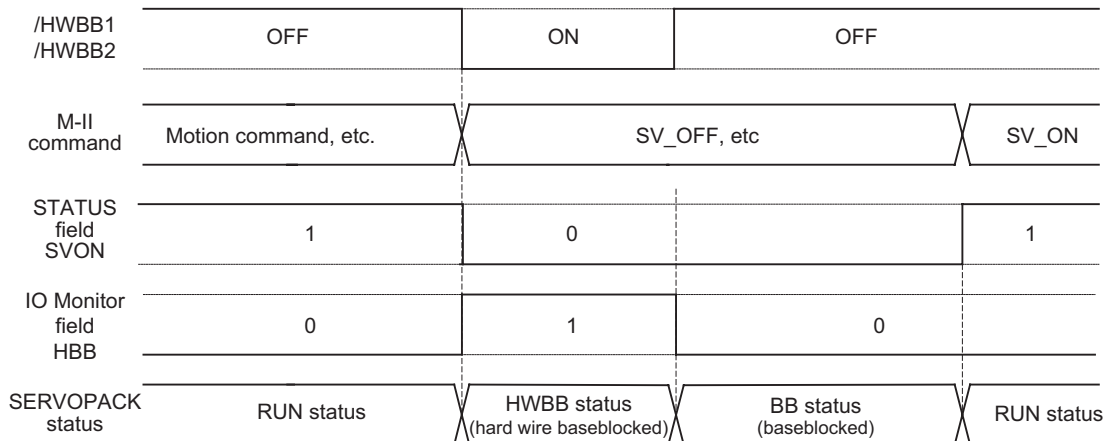

■ When an HWBB Signal is Input:

Monitor the HWBB input signal and SCM output signal status, or HBB signal status in IO Monitor field. If a forced stop status is detected, send a command such as SV_OFF to stop the motor.

■ Restoration from Stop Status:

Reset the HWBB1 or HWBB2 signal, and then send a command other than SV_ON, such as SV_OFF. Then, restore the controller and system. When the controller and system are restored, turn the servo ON using the operation sequence to turn the servo ON.

- Note 1. If the SERVOPACK enters HWBB status while sending an SV_ON command, reset the /HWBB1 or /HWBB2 signal and then send a command other than SV_ON, such as SV_OFF. Then, send the SV_ON command again to restore the normal operation status.
2. If the SERVOPACK enters HWBB status during execution of an SV_OFF, INTERPOLATE, LATCH, POSING, FEED, EX_POSING, or ZRET command, a command warning will occur since the SERVOPACK status changes to Servo OFF status. Execute the Clear Alarm or Warning (ALM_CLR) command to restore normal operation.

2.4.5 Operation Sequence At Occurrence of Alarm

When the ALM bit in STATUS field of response turns on (= 1), send SV_OFF command. Use ALM_RD command to check the alarm occurrence status.

To clear the alarm status, send ALM_CLR command after removing the cause of alarm. However, the alarms that require turning the power supply off and then on again to clear the alarm status, sending ALM_CLR command will not clear the alarm status.

If a communications alarm A.E5□ or A.E6□ occurs, send ALM_CLR command to reset the alarm and then send SYNC_SET command.

2.5 Setting the Origin Before Starting Operation

2.5.1 When Using an Incremental Encoder

When an incremental encoder is used in the slave station, carry out a homing operation after turning ON the power supply.

After the origin is set, set the reference coordinate system to determine the work coordinate origin as required:

1. Setting the Reference Coordinate System Using ZRET Command

The master station (controller) uses ZRET command to return the slave station to the origin and sets the reference coordinate system based on the origin.

2. Setting the Reference Coordinate System Using POS_SET Command

The master station (controller) uses POS_SET command to set the reference coordinate system of the slave station.

i) Position to the reference position.

ii) Send the POS_SET command with POS_SET_MODE.POS_SEL = APOS (= 3),
POS_SET_MODE.REFE = 1, and POS_DATA = reference position.

ZPOINT and software limits are enabled after the reference coordinate system has been set.

2.5.2 When Using an Absolute Encoder

When an absolute encoder is used in the slave station, SENS_ON command can be used to set the reference coordinate system of the slave station. The reference coordinate system will be set according to the position detected by the absolute encoder and the coordinate system offset of the encoder (i.e., the offset between the encoder's coordinate system and the reference coordinate system (device built-in parameter).

The relationship between the reference coordinate system (POS and APOS), the encoder's coordinate system, and the coordinate system offset of the encoder are shown in the following figure.

POS: Reference position

APOS: Feedback position

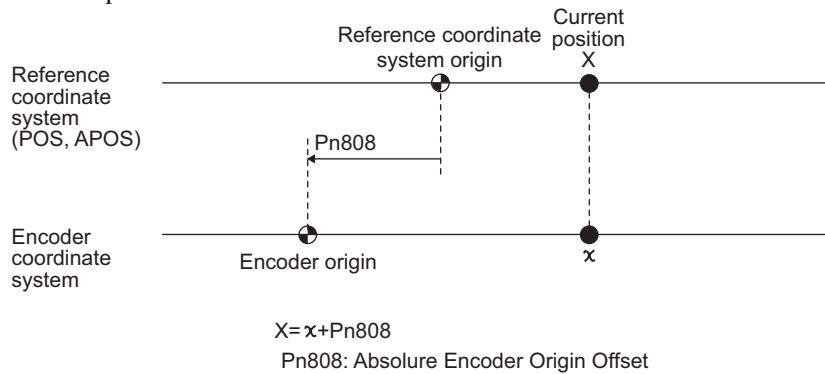

Commands for Preparation Process

This chapter describes the MECHATROLINK-II commands needed to prepare for operation.

3.1	No Operation (NOP: 00H)	3-3
3.2	Release MECHATROLINK-II Connection (DISCONNECT: 0FH)	3-6
3.3	Establish MECHATROLINK-II Connection (CONNECT: 0EH)	3-7
3.4	Start Synchronous Communications (SYNC_SET: 0DH)	3-9
3.5	Check Device ID (ID_RD: 03H)	3-10
3.6	Set Parameters (PRM_WR: 02H)	3-12
3.7	Set and Save Parameters in Non-volatile Memory (PPRM_WR: 1CH)	3-13
3.8	Validate Parameters (Setup) (CONFIG: 04H)	3-14
3.9	Turn Encoder Power Supply ON (SENS_ON: 23H)	3-15
3.10	Turn Servo ON (SV_ON: 31H)	3-18
3.11	Turn Encoder Power Supply OFF (SENS_OFF: 24H)	3-20
3.12	Turn Servo OFF (SV_OFF: 32H)	3-21
3.13	Read Parameters (PRM_RD: 01H)	3-22
3.14	Check SERVOPACK Status (SMON: 30H)	3-23
3.15	Read Alarm or Warning (ALM_RD: 05H)	3-24
3.16	Clear Warning or Alarm (ALM_CLR: 06H)	3-26
3.17	Set Coordinate System (POS_SET: 20H)	3-27
3.18	Monitor and Adjust Settings (ADJ: 3EH)	3-28

Commands for Preparation Process

Operation	Command to Send	Description
Confirmation of completion of SERVOPACK initialization	NOP, DISCONNECT	Checks if the SERVOCK has been initialized to be ready for communications or not.
Establishment of MECHATROLINK-II connection	CONNECT	Establishes communications connection and starts WDT count.
Synchronous communications start	SYNC_SET	Starts synchronous communications.
Device ID check	ID_RD	Checks information such as device ID.
Parameter setting	PRM_WR	Sets the parameters required for device. (When parameters are managed by a controller)
Parameter setting and saving	PPRM_WR	Sets the parameters required for device and saves them in the non-volatile memory. (When parameters are managed by SERVOPACK.)
Validation of parameter settings (Setup)	CONFIG	Enables the set parameters.
Encoder power supply ON	SENS_ON	Turns on the encoder power supply to get position data.
Servo ON	SV_ON	Turns the servo on.
Encoder power supply OFF	SENS_OFF	Turns off the encoder power supply off.
Servo OFF	SV_OFF	Turns the servo off.
Parameter read-out	PRM_RD	Reads active parameters. (When parameters are managed by a controller)
SERVOPACK status monitoring	SMON	Monitors the SERVOPACK status.
Alarm and warning read-out	ALM_RD	Reads the current alarm or warning and the alarm occurrence history.
Clearing alarm or warning status	ALM_CLR	Clears the current alarm or warning status and the alarm occurrence history.
Coordinate system setting	POS_SET	Sets the coordinate system.
Data monitoring and adjustment	ADJ	Monitors and adjusts the set data.

3.1 No Operation (NOP: 00H)

After turning on the control and main circuit power supplies, send NOP command to check if initialization of SERVOPACK has been completed or not.

(1) No Operation (NOP: 00H)

The specifications of the NOP command are shown below.

Byte	NOP		Description								
	Command	Response									
1	00H	00H	Phases in which the command can be executed	All phases	Synchronization classification	Asynchronous command					
2		ALARM	Processing time	Within communications cycle	Subcommand	Can be used.					
3		STATUS		<ul style="list-style-type: none"> Returns the ALM, WARNG, and CMDRDY bits in STATUS field. Other bits will not be specified. The response will be NOP from the moment the power is turned on until the initialization of SERVOPACK is completed. During this time, CMDRY = 0. 							
4											
5											
6											
7											
8											
9											
10											
11											
12											
13											
14											
15											
16		WDT						RWDT			
17	Subcommand area	Subcommand area									
18											
19											
20											
21											
22											
23											
24											
25											
26											
27											
28											
29											

(2) ALARM

The uppermost two digits of the SERVOPACK alarm code are set in the ALARM field of the response. For example, ALARM = 02 when a parameter checksum error 1 (A.020) occurs. If no alarm occurs, ALARM = 00.

For details on alarms and alarm codes, refer to *Σ -V Series SGM□/SGDV User's Manual Design and Maintenance MECHATROLINK-II Communications Reference/Rotary Servomotors(SIEPS80000046)/Linear Servomotors (SIEPS8000048)*.

(3) Status Field Specifications

The status field is used to monitor the SERVOPACK status.
The following table shows the bit allocation in the status field.

D7	D6	D5	D4	D3	D2	D1	D0
PSET/ V_CMP	ZPOINT	–	PON	SVON	CMDRDY	WARNG	ALM

D15	D14	D13	D12	D11	D10	D9	D8
–	–	N_SOT	P_SOT	NEAR/ V_LIM	L_CMP	T_LIM	DEN/ZSPD

The following table explains each bit value and its status.

Bit	Name	Value	Description
D0	ALM	0	No alarm
		1	Alarm occurs.
D1	WARNG	0	No warning
		1	Warning occurs.
D2	CMDRDY	0	Command cannot be received (busy).
		1	Command can be received (ready).
D3	SVON	0	Servo OFF
		1	Servo ON
D4	PON	0	Main power supply OFF
		1	Main power supply ON
D5			
D6	ZPOINT	0	Out of home position range
		1	Within home position range
D7	PSET (During position control)	0	Out of positioning complete range
		1	Within positioning complete range (The output is completed (DEN = 1) and APOS is within the positioning complete range.)
	V_CMP (During speed control)	0	Speed does not coincide.
		1	Speed coincides.
D8	DEN (During position control)	0	During output
		1	Output completed
	ZSPD (During speed control)	0	Zero speed not detected
		1	Zero speed detected
D9	T_LIM	0	Not during torque (force) limit
		1	During torque (force) limit
D10	L_CMP	0	Latch not completed
		1	Latch completed
D11	NEAR (During position control)	0	Out of positioning proximity
		1	Within positioning proximity
	V_LIM (During speed control)	0	Speed limit not detected
		1	Speed limit detected
D12	P_SOT	0	OT signal is OFF.
		1	OT signal is ON.

Bit	Name	Value	Description
D13	N_SOT	0	OT signal is OFF.
		1	OT signal is ON.
D14			
D15			

(4) Details WDT and RWDT

The watchdog timer data will be set in WDT and RWDT of NOP command and response as shown below.

	D7	D4	D3	D0	
WDT	SN: Copy of RSN in RWDT		MN: Incremented by 1 each communications cycle		MN: Master station watchdog timer count
	D7	D4	D3	D0	
RWDT	RSN: Incremented by 1 each communications cycle		RMN: Copy of MIN in WDT		RSN: SERVOPACK's watchdog timer count

The watchdog timer is checked after synchronous communications has been established.
The SERVOPACK watchdog timer data will be refreshed whether synchronous communications is established or not.

3.2 Release MECHATROLINK-II Connection (DISCONNECT: 0FH)

The connection must be released at the end of communications.
Send a DISCONNECT command to release the connection.

(1) Disconnection (DISCONNECT: 0FH)

The specifications of the DISCONNECT command are shown below.

Byte	DISCONNECT		Description			
	Command	Response				
1	0FH	0FH	Phases in which the command can be executed	All phases	Synchronization classification	Asynchronous command
2		ALARM	Processing time	Communications cycle or more (Within 5 s)	Subcommand	Cannot be used
3		STATUS	<ul style="list-style-type: none"> • Releases the MECHATROLINK-II connection, and the SERVOPACK changes communications to Phase 1. • When this command is received, the following operations will be performed. <ul style="list-style-type: none"> - The SERVOPACK changes communications to Phase 1. - The SERVOPACK changes to Servo OFF. - The reference point setting becomes invalid. - The position data is initialized. - BRAKE signal turns ON. - If an alarm has occurred, releasing the connection will not clear the alarm status. The set parameter data (saved in the volatile memory) will remain valid. - To re-establish connection, carry out operations in the same sequence as when turning ON the power supply and set the required parameters again. 			
4						
5						
6						
7						
8						
9						
10						
11						
12						
13						
14						
15						
16	WDT	RWDT				

Note: Always send a DISCONNECT command for at least two communications cycles.

3.3 Establish MECHATROLINK-II Connection (CONNECT: 0EH)

Send a CONNECT command to establish a MECHATROLINK-II communications connection. When the connection is established, the WDT (watchdog timer) count starts.

(1) MECHATROLINK-II Connection (CONNECT: 0EH)

The specifications of the CONNECT command are shown below.

Byte	CONNECT		Description			
	Command	Response				
1	0EH	0EH	Phases in which the command can be executed	Phase 1	Synchronization classification	Asynchronous command
2		ALARM	Processing time	Communications cycle or more (Within 5 s)	Subcommand	Cannot be used
3		STATUS	<ul style="list-style-type: none"> Establishes a MECHATROLINK-II connection and sets the communications mode according to COM_MODE. VER: Version. Set VER to 21H (Version 2.1) COM_MOD: Sets the communications mode. Refer to (2) <i>Details of COM_MOD</i> for details. COM_TIM: Sets the communications cycle. The communications cycle must satisfy the following equation within the range between 1 and 32. $0.25 \text{ [ms]} \leq \text{Transmission cycle [ms]} \times \text{COM_TIM} \leq 32 \text{ [ms]}$ A warning will occur and the command will be ignored in the following cases. <ul style="list-style-type: none"> If COM_MODE is out of the setting range: Data setting warning 2 (A.94B) If COM_TIM is out of the setting range: Data setting warning 2 (A.94B) If the transmission bytes is 17 but SUBCMD = 1: Data setting warning 2 (A.94B) If the transmission speed is set to 10 Mbps but VER is not set to 21H: Data setting warning 2 (A.94B) If the SERVOPACK is being operated by SigmaWin or digital operator: Command warning 1 (A.95A) Slave stations will not accept commands other than CONNECT, DISCONNECT, and NOP before the connection is established. If a command other than CONNECT, DISCONNECT, and NOP is sent before the connection is established, NOP is always returned as the response. 			
4						
5	VER	VER				
6	COM_MOD	COM_MOD				
7	COM_TIM	COM_TIM				
8						
9						
10						
11						
12						
13						
14						
15						
16	WDT	RWDT				

Note: Slave stations will not accept any MECHATROLINK-II command while a motion command such as JOG is being executed to run the motor through SigmaWin or by digital operator.

(2) Details of COM_MOD

COM_MOD bit allocation and each bit status are described below.

D7	D6	D5	D4	D3	D2	D1	D0
SUBCMD	0	0	0	DTMOD		SYNCMOD	0

- SYNCMOD: Sets the synchronization mode.
SYNCMOD = 0: Asynchronous communications
SYNCMOD = 1: Synchronous communications
- DTMOD: Sets the data transmission method.
DTMOD = 00 or 11: Single transmission
DTMOD = 01: Continuous transmission
Normally, set DTMOD to 00.
- SUBCMD: Specify whether to use subcommands or not.
SUBCMD = 0: Do not use subcommands
SUBCMD = 1: Use subcommands

Note: When SYNCMOD = 0, it is necessary to send SYNC_SET command to enter Phase 3.

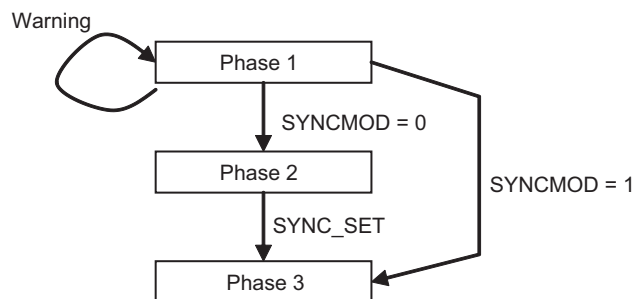

(3) Transmission Cycle and Communications Cycle

The table below provides the applicable communications cycle and the maximum number of connectable stations for each transmission cycle setting.

Transmission Cycle	Applicable Communications Cycle	Transmission Bytes	
		17-byte	32-byte
		Connectable Max.	Number of Stations
0.25 ms	0.25 ms to 8.00 ms (in 0.25-ms units)	2	1
0.50 ms	0.50 ms to 16.00 ms (in 0.50-ms units)	7	4
0.75 ms	0.75 ms to 24.00 ms (in 0.75-ms units)	11	7
1.00 ms	1.00 ms to 32.00 ms (in 1.00-ms units)	15	9
1.50 ms	1.50 ms to 32.00 ms (in 1.50-ms units)	23	15
2.00 ms	2.00 ms to 32.00 ms (in 2.00-ms units)	30	21
2.50 ms	2.50 ms to 2.00 ms (in 2.50-ms units)	30	26
3.00 ms	3.00 ms to 32.00 ms (in 3.00-ms units)	30	30
3.50 ms	3.50 ms to 32.00 ms (in 3.50-ms units)	30	30
4.00 ms	4.00 ms to 32.00 ms (in 4.00-ms units)	30	30

Note: Communications retry stations can be connected as long as the total number of connected stations, including the retry stations, is within the connectable max. number of stations. The maximum number of retry stations is the difference between the connectable max. number of stations and the number of actually connected slave stations, but limited to 7.

Note that the connectable max. number of stations may differ depending on the controller specifications.

3.4 Start Synchronous Communications (SYNC_SET: 0DH)

This section describe how to start synchronization to change a communications phase from phase 2 to phase 3.

When SYNCMOD bit of the COM_MOD of CONNECT command is set to 1, the communications phase will change from phase 1 to phase 3 at the moment the connection is established. In this case, it is not necessary to send a SYNC_SET command.

(1) Start Synchronous Communications (SYNC_SET: 0DH)

The specifications of the SYNC_SET command are described below.

Byte	SYNC_SET		Description			
	Command	Response				
1	0DH	0DH	Phases in which the command can be executed	Phase 2	Synchronization classification	Asynchronous command
2		ALARM	Processing time	Communications cycle or more (Within 5 s)	Subcommand	Cannot be used
3		STATUS	<ul style="list-style-type: none"> Starts synchronous communications. Switched from phase 2 to phase 3. Synchronization is made at the WDT changing edge. However, if WDT errors are masked by parameter Pn800.0, processing is completed when this command is received. During phase 3, the slave ignores this command and returns a normal response without a warning. If the slave station in Servo ON status receives this command in phase 2, the slave station enters Servo OFF status. At occurrence of the following alarms and warnings, this command must be transmitted to restart synchronous communications. <ul style="list-style-type: none"> Command warning 1 (A.95A) occurs when this command is used in phase 1 MECHATROLINK-II synchronization Error (A.E50) MECHATROLINK-II synchronization failed (A.E51) MECHATROLINK-II Communications Error (A.E60) MECHATROLINK-II Transmission Cycle Error (A.E61) Command warning 1 (A.95A) occurs when this command is used while operating the servo using SigmaWin or a digital operator 			
4						
5						
6						
7						
8						
9						
10						
11						
12						
13						
14						
15						
16	WDT	RWDT				

3.5 Check Device ID (ID_RD: 03H)

Send ID_RD command to read the device ID for confirmation.

(1) Read ID (ID_RD: 03H)

The specifications of the ID_RD command are described below.

Byte	ID_RD		Description			
	Command	Response				
1	03H	03H	Phases in which the command can be executed	Phase 2 and 3	Synchronization classification	Asynchronous command
2		ALARM	Processing time	Within communications cycle	Subcommand	Can be used
3		STATUS	<ul style="list-style-type: none"> • Reads the device ID for confirmation. • Use DEVICE_CODE to specify the device ID to be read. • Use OFFSET to specify which data of the device ID is to be read out. • Use SIZE to specify the number of data (bytes) to be read out. 			
4						
5				DEVICE_CODE	DEVICE_CODE	
6	OFFSET	OFFSET				
7	SIZE	SIZE				
8		ID				
9						
10						
11						
12						
13						
14						
15						
16	WDT	RWDT				
17	Subcommand area	Subcommand area				
18						
19						
20						
21						
22						
23						
24						
25						
26						
27						
28						
29						

(2) Device ID Specifications

The specifications of the device ID are described below.

Device Type/Name		OFFSET DEVICE_CODE	ID Data																			
			00	01	02	03	04	05	06	07	08	09	0A	0B	0C	0E	0D	0F	10	11	12	13
SERVOPACK	Model	00H	S	G	D	*1	-	*2	*2	*2	*3	*4	*4	*4	*5	*6	*6	*6	*6	*6	*6	00
	Software version	02H	Ver.																			
Servomotor	Model	20H	S	G	M	*7	*7	-	*8	*8	*9	*10	*11	*12	*13	00						
	Encoder software version	12H	Ver.																			
External Encoder	Model	30H																				
	Software version	32H	Ver.																			
Safety Option Unit	Model	60H																				
	Software version	62H	Ver.																			
Feedback Option Unit	Model	70H																				
	Software version	72H	Ver.																			

- SERVOPACK Model
 - *1: Model code, *2: Current capacity, *3: Power supply voltage specifications, *4: Interface specifications, *5: Design revision order, *6: Options
- Servomotor Model
 - *7: Model code, *8: Rated output, *9: Power supply voltage, *10: Encoder type, *11: Design revision order, *12: Shaft-end specifications, *13: Options
- Software version is binary data.
- Model is expressed in ASCII code and “00 (NULL)” is added at the end of each character string.
- 50H and 52H of DEVICE_CODE are reserved for system.
- When the Safety Option unit or/and Feedback Option unit are not connected, 0 is set to all the ID data.
- For an external encoder, the ID of the encoder connected to the Feedback Option unit is set. (Therefore, 0 is set to all the ID data when no Feedback Option unit is connected.)
- When an encoder option for fully-closed loop control is connected to the Feedback Option unit, 0 is set to all the ID data of Feedback Option unit.

3.6 Set Parameters (PRM_WR: 02H)

Send PRM_WR command to set parameters when parameters are managed by a controller. Parameters will be set without being saved in the non-volatile memory of SERVOPACK.

(1) Write Parameter (PRM_WR: 02H)

The specifications of the PRM_WR command are described below.

Byte	PRM_WR		Description			
	Command	Response				
1	02H	02H	Phases in which the command can be executed	Phase 2 and 3	Synchronization classification	Asynchronous command
2		ALARM	Processing time	Within 200 ms	Subcommand	Cannot be used
3		STATUS	<ul style="list-style-type: none"> Writes parameters. The parameters will not be saved in the non-volatile memory. For parameters that require turning the power supply OFF and ON again to be validated, it is necessary to send a CONFIG command to validate the settings. Use NO to specify the parameter to be written. Use SIZE to specify the number of data (bytes) of the parameter to be written. PARAMETER is the data to be written. A warning will occur and the command will be ignored in the following cases. <ul style="list-style-type: none"> - When editing using SigmaWin or a digital operator: Command warning 1 (A.95A) - NO is set out of the range: Data setting warning 1 (A.94A) - SIZE does not match: Data setting warning 4 (A.94D) - PARAMETER is out of the range: Data setting warning 2 (A.94B) 			
4						
5	NO	NO				
6						
7	SIZE	SIZE				
8	PARAMETER	PARAMETER				
9						
10						
11						
12						
13						
14						
15						
16	WDT	RWDT				

- Example of NO

For the parameter Pn80D, the data is set in little endian as shown below.

Byte	Data
5	0D
6	08

3.7 Set and Save Parameters in Non-volatile Memory (PPRM_WR: 1CH)

Send a PPRM_WR command to save parameters in the SERVOPACK.

(1) Write Non-volatile Parameter (PPRM_WR: 1CH)

The specifications of the PPRM-WR command are described below.

Byte	PPRM_WR		Description			
	Command	Response				
1	1CH	1CH	Phases in which the command can be executed	Phase 2 and 3	Synchronization classification	Asynchronous command
2		ALARM	Processing time	Within 200 ms	Subcommand	Cannot be used
3		STATUS	<ul style="list-style-type: none"> Saves parameters in the non-volatile memory. For parameters that require turning the power supply OFF and ON again to be validated, it is necessary to send a CONFIG command to validate the settings. A warning will occur and the command will be ignored in the following cases. <ul style="list-style-type: none"> - NO is out of the range: Data setting warning 1 (A.94A) - SIZE does not match: Data setting warning 4 (A.94D) - PARAMETER is out of the range: Data setting warning 2 (A.94B) - While editing using SigmaWin or a digital operator: Command warning 1 (A.95A) 			
4						
5		NO		NO		
6		SIZE		SIZE		
7	PARAMETER	PARAMETER				
8						
9						
10						
11						
12						
13						
14						
15	WDT	RWDT				



IMPORTANT

Do not turn off the power supply while the parameter is being written (CMDRDY = 0).

3.8 Validate Parameters (Setup) (CONFIG: 04H)

The set parameters need to be validated (setup) using a CONFIG command.

Executing this command recalculates all currently set parameters and initializes positions, output signals, etc.

(1) Set Up Device (CONFIG: 04H)

The specifications of the CONFIG command are described below.

Byte	CONFIG		Description			
	Command	Response				
1	04H	04H	Phases in which the command can be executed	Phase 2 and 3	Synchronization classification	Asynchronous command
2		ALARM	Processing time	Within 5 s	Subcommand	Cannot be used
3		STATUS		<ul style="list-style-type: none"> Recalculates all currently set parameters and initializes position, etc. The SERVOPACK will change to Servo OFF if this command is received when the SERVOPACK is Servo ON. The command warning 1 (A.95A) will occur and the command will be ignored if this command is sent: <ul style="list-style-type: none"> When editing using SigmaWin or a digital operator Refer to (2) <i>Status and Output Signal during CONFIG Command Execution</i> for details on status and output signal during CONFIG command execution. 		
4						
5						
6						
7						
8						
9						
10						
11						
12						
13						
14						
15						
16	WDT	RWDT				

(2) Status and Output Signal during CONFIG Command Execution

The status and output signal during CONFIG command execution are listed below.

Status and Output Signal	Before CONFIG	During CONFIG	After CONFIG
ALM (status)	Current status	Current status	Current status
CMDRDY (status)	1	0	1
Other status	Current status	Not specified	Current status
ALARM (code)	Alarm currently occurred	Alarm currently occurred	Alarm currently occurred
ALM (CN1 output signal)	Current status	Current status	Current status
/S-RDY (CN1 output signal)	Current status	OFF	Current status
Other output signals	Current status	Not specified	Current status

3.9 Turn Encoder Power Supply ON (SENS_ON: 23H)

Send SENS_ON command to turn ON the encoder power supply.

(1) Turn Sensor ON (SENS_ON: 23H)

The specifications of the SENS_ON command are described below.

Byte	SENS_ON		Description							
	Command	Response								
1	23H	23H	Phases in which the command can be executed	Phase 2 and 3	Synchronization classification	Asynchronous command				
2		ALARM	Processing time	Within 2 s	Subcommand	Cannot be used				
3		STATUS	<ul style="list-style-type: none"> Obtains the initial position data and creates the present position when an absolute encoder is used. The reference point, home position (ZPOINT), and software limits will be enabled when an absolute encoder is used. After having used this command, the position data must be monitored and the coordinate system of host controller must be setup. 							
4										
5		MONITOR1								
6										
7										
8										
9										
10										
11										
12										
13		SEL_MON1/2					SEL_MON1/2			
14		IO_MON								
15										
16	WDT	RWDT								

(2) Monitor Selection and Monitor Information Field Specifications: SEL_MON1/2/3/4, MONITOR 1/2/3/4

The monitor selection and monitor information (SEL_MON1/2/3/4, MONITOR1/2/3/4) field is used to select the Servo monitor information.

- Setting Method:

Set MONITOR 1/2/3/4 monitor codes in SEL_MON1/2/3/4 allocated in the thirteenth byte of the main command or in the reserved area of the nineteenth byte of the subcommand.

SEL_MON1/2/3/4 allocation is shown below.

D7	D6	D5	D4	D3	D2	D1	D0
SEL_MON2				SEL_MON1			
D7	D6	D5	D4	D3	D2	D1	D0
SEL_MON4				SEL_MON3			

(3) Monitor Information Field Specifications: MONITOR 1/2/3/4

The MONITOR 1/2/3/4 monitor codes are listed below.

Monitor Code	Name	Description	Unit
0	POS	Reference position in reference coordinate system (position after reference filtering)	Reference unit
1	MPOS	Reference position	Reference unit
2	PERR	Position error	Reference unit
3	APOS	Feedback position in machine coordinate system	Reference unit
4	LPOS	Feedback latch position in machine coordinate system	Reference unit
5	IPOS	Reference position in reference coordinate system (position before reference filtering)	Reference unit
6	TPOS	Target position in reference coordinate system	Reference unit
7			
8	FSPD	Feedback speed	Position/torque (force) control: reference units/s Speed control: Maximum speed/4000000H
9	CSPD	Reference speed	Position control: Reference units/s Speed control: Maximum speed/4000000H
A	TSPD	Target speed	Position control: Reference units/s Speed control: Maximum speed/4000000H
B	TRQ	Torque (force) reference (The rated torque is 100%.)	Position/speed control: % (The rated torque is 100%.) Torque (force) control: Maximum torque (force)/4000000H
C			
D			
E	OMN1	Option monitor 1 selected in Pn824	
F	OMN2	Option monitor 2 selected in Pn825	

(4) IO Monitor Field Specifications: IO_MON

The IO monitor field is used to monitor the I/O signal status of the SERVOPACK.

I/O signal allocation is shown below.

D7	D6	D5	D4	D3	D2	D1	D0
EXT2	EXT1	PC	PB	PA	DEC	N_OT	P_OT

D15	D14	D13	D12	D11	D10	D09	D08
IO15	IO14	IO13	IO12	–	HBB	BRK	EXT3

Bit	Name	Contents	Value	Status
D0	P_OT	Forward run prohibited input	0	OFF
			1	ON
D1	N_OT	Reverse run prohibited input	0	OFF
			1	ON
D2	DEC	Homing deceleration LS input	0	OFF
			1	ON
D3	PA	Encoder phase A input	0	OFF
			1	ON
D4	PB	Encoder phase B input	0	OFF
			1	ON
D5	PC	Encoder phase C input	0	OFF
			1	ON
D6	EXT1	First external latch signal input	0	OFF
			1	ON
D7	EXT2	Second external latch signal input	0	OFF
			1	ON
D8	EXT3	Third external latch signal input	0	OFF
			1	ON
D9	BRK	Brake output	0	Released
			1	Locked
D10	HBB	Stop signal input, OR of HWBB1 signal and HWBB2 signal	0	OFF (Forced stop released)
			1	ON (Forced stop)
D11		Reserved	0	
D12	IO12	CN1 input signal selected in Pn81E.0	0	OFF
			1	ON
D13	IO13	CN1 input signal selected in Pn81E.1	0	OFF
			1	ON
D14	IO14	CN1 input signal selected in Pn81E.2	0	OFF
			1	ON
D15	IO15	CN1 input signal selected in Pn81E.3	0	OFF
			1	ON

3.10 Turn Servo ON (SV_ON: 31H)

Send the SV_ON command to power the servomotor and make it ready for operation.

(1) Servo ON (SV_ON: 31H)

The specifications of the SV_ON command are described below.

Byte	SV_ON		Description			
	Command	Response				
1	31H	31H	Phases in which the command can be executed	Phase 2 and 3	Synchronization classification	Asynchronous command
2		ALARM	Processing time	Normally 50 ms (10 s max.)	Subcommand	Can be used
3	OPTION	STATUS	<ul style="list-style-type: none"> • Powers the servomotor and makes it ready for operation. • Command warning 1 (A.95A) will occur and the command will be ignored if the command is sent: <ul style="list-style-type: none"> - During alarm occurrence (When ALM of STATUS is 1) - When the main power supply is OFF (PON of STATUS is 0) - When the HWBB signal is ON (HWBB of IO_MON is 1) - Before completion of execution of SENS_ON when an absolute encoder is used • OPTION field can be selected • Upon completion of execution of this command, the reference position (POS) must be read, and the controller coordinate system must be set up. 			
4						
5	MONITOR1					
6						
7						
8						
9	MONITOR2					
10						
11						
12						
13	SEL_MON1/2	SEL_MON1/2				
14		IO_MON				
15						
16	WDT	RWDT				
17	Subcommand area	Subcommand area				
18						
19						
20						
21						
22						
23						
24						
25						
26						
27						
28						
29						

(2) OPTION Field Specifications

The option field is used to add functions to a motion command.

Set the functions to be added to a motion command in the main command third and fourth bytes reserved for the option field.

The option field of the Σ -V series SERVOPACK is set by default as shown below.

To change the default setting, set the parameter Pn81F as Pn81F = $\square\square\square 1$, and set the bits to which functions are to be allocated using the parameters Pn82A to Pn82E. The change must be validated by turning the power supply OFF and then ON again or by sending a CONFIG command.

• OPTION Field Default Setting.

D7	D6	D5	D4	D3	D2	D1	D0
0	0	0	ACCFIL		0	0	0

D15	D14	D13	D12	D11	D10	D9	D8
N_CL	P_CL	P_PI_CLR	V_PPI	0	0	G_SEL	

• Functions That Can Be Allocated to Bits of the OPTION Field

Name	Description	Value	Details	Default Setting	
ACCFIL (2 bits)	Acceleration/Deceleration filter	0	No acceleration/deceleration filter	D3, D4	
		1	Exponential function acceleration/deceleration		
		2	S-curve acceleration/deceleration		
		3	Do not set.		
G_SEL (2 bits)	Gain switching	0	First gain	D8, D9	
		1	Second gain		
		2	Reserved (invalid)		
		3	Reserved (invalid)		
V_PPI (1 bit)	Speed loop P/PI control	0	PI control	D12	
		1	P control		
P_PI_CLR (1 bit)	Position loop position integral clear	0	Does not clear.	D13	
		1	Clears.		
P_CL (1 bit)	Forward torque (force) limit	0	Does not control torque (force).	D14	
		1	Controls torque (force).		
N_CL (1 bit)	Reverse torque (force) limit	0	Does not control torque (force).	D15	
		1	Controls torque (force).		
LT_DISABLE (1 bit)	Latch signal input disabled	0	Enables latch signal input.	Not allocated	
		1	Disables latch signal input.		
BANK_SEL1 (4 bits)	Bank selector 1 (Bank for acceleration/deceleration parameter switching)	0 to 15	Bank 0 to Bank 15	Not allocated	
OUT_SIGNAL (3 bits)	I/O signal output command	BIT 0	0	SO1 output signal OFF	Not allocated
			1	SO1 output signal ON	
		BIT 1	0	SO2 output signal OFF	
			1	SO2 output signal ON	
		BIT 2	0	SO3 output signal OFF	
			1	SO3 output signal ON	

Note 1. Do not allocate more than one signal to one bit. Otherwise, multiple signals will be controlled by one bit.

2. The bits to which no function is allocated will act as it is set to 0 (zero).

3.11 Turn Encoder Power Supply OFF (SENS_OFF: 24H)

Send a SENS_OFF command to turn OFF the encoder power supply.

(1) Turn Sensor OFF (SENS_OFF: 24H)

The specifications of the SENS_OFF command are described below.

Byte	SENS_OFF		Description			
	Command	Response				
1	24H	24H	Phases in which the command can be executed	Phase 2 and 3	Synchronization classification	Asynchronous command
2		ALARM	Processing time	Within 2 sec	Subcommand	Cannot be used
3		STATUS	<ul style="list-style-type: none"> Turn the encoder OFF. The position data will be not specified when an absolute encoder is used. The reference point, origin (ZPOINT), and software limits will be invalid. Command warning 1 (A.95A) will occur and the command will be ignored if the command is sent: <ul style="list-style-type: none"> While the servo is ON 			
4						
5		MONITOR1				
6						
7						
8						
9		MONITOR2				
10						
11						
12						
13	SEL_MON1/2	SEL_MON1/2				
14		IO_MON				
15						
16	WDT	RWDT				

3.12 Turn Servo OFF (SV_OFF: 32H)

Send an SV_OFF command to stop current flow through the servomotor.

(1) Servo OFF (SV_OFF: 32H)

The specifications of the SV_OFF command are described below.

Byte	SV_OFF		Description				
	Command	Response					
1	32H	32H	Phases in which the command can be executed	Phase 2 and 3	Synchronization classification	Asynchronous command	
2		ALARM	Processing time	The time set in Pn506 (500 ms max.)	Subcommand	Can be used	
3		STATUS	<ul style="list-style-type: none"> Stops current flow through the servomotor. When Pn829 (SVOFF waiting time at deceleration to stop) is set to a value other than 0, the servo will be turned OFF after the servomotor decelerates to a stop according to the deceleration constant for stopping set by the parameter. (The servomotor decelerates to a stop in position control mode.) When Pn829 (SVOFF waiting time at deceleration to a stop) is set to 0, the servo will be turned OFF immediately after reception of this command. (The control mode before receiving SV_OFF command remains unchanged.) Executing the SV_OFF command will cancel the speed reference, speed feed forward, torque (force) feed forward, and torque (force) limits set by a position/speed control command. 				
4							
5		MONITOR1					
6							
7							
8							
9		MONITOR2					
10							
11							
12							
13		SEL_MON1/2		SEL_MON1/2			
14		IO_MON					
15							
16	WDT	RWDT					
17	Subcommand area	Subcommand area					
18							
19							
20							
21							
22							
23							
24							
25							
26							
27							
28							
29							

3.13 Read Parameters (PRM_RD: 01H)

Send a PRM_RD command to read out parameters.

(1) Read Parameter (PRM_RD: 01H)

The specifications of the PRM_RD command are described below.

Byte	PRM_RD		Description			
	Command	Response				
1	01H	01H	Phases in which the command can be executed	Phase 2 and 3	Synchronization classification	Asynchronous command
2		ALARM	Processing time	Within 200 ms	Subcommand	Can be used
3		STATUS	<ul style="list-style-type: none"> • Reads out parameters. • A warning will occur and the command will be ignored in the following cases. <ul style="list-style-type: none"> - While editing using a digital operator: Command warning 1 (A.95A) - NO is out of the range: Data setting warning 1 (A.94A) - SIZE does not match: Data setting warning 4 (A.94D) 			
4						
5	NO	NO				
6						
7	SIZE	SIZE				
8		PARAMETER				
9						
10						
11						
12						
13						
14						
15						
16	WDT	RWDT				

3.14 Check SERVOPACK Status (SMON: 30H)

Send a SMON command to check the SERVOPACK status.

(1) Status Monitoring (SMON: 30H)

The specifications of the SMON command are described below.

Byte	SMON		Description									
	Command	Response										
1	30H	30H	Phases in which the command can be executed	Phase 2 and 3	Synchronization classification	Asynchronous command						
2		ALARM	Processing time	Within communications cycle	Subcommand	Can be used						
3		STATUS	MONITOR1	<ul style="list-style-type: none"> Reads the current status of the SERVOPACK. 								
4												
5												
6												
7												
8												
9												
10								MONITOR2				
11												
12												
13								SEL_MON1/2	SEL_MON1/2			
14								IO_MON				
15												
16	WDT	RWDT										
17	Subcommand area	Subcommand area										
18												
19												
20												
21												
22												
23												
24												
25												
26												
27												
28												
29												

3.15 Read Alarm or Warning (ALM_RD: 05H)

Send an ALM_RD command to read out the current alarm/warning and the alarm history.

(1) Read Alarm or Warning (ALM_RD: 05H)

The specifications of the ALM_RD command are described below.

Byte	ALM_RD		Description			
	Command	Response				
1	05H	05H	Phases in which the command can be executed	Phase 2 and 3	Synchronization classification	Asynchronous command
2		ALARM	Processing time	See <i>ALM_RD_MOD Specifications</i> on the next page.	Subcommand	Cannot be used
3		STATUS	ALM_RD_MOD	<ul style="list-style-type: none"> Reads the following alarm and warning status. <ul style="list-style-type: none"> Current alarm/warning status Alarm history* (Warnings and communications alarms A.E50 and A.E60 will not be read out since they are not preserved in the history.) See (2) <i>ALM_RD_MOD Specifications</i> for details on ALM_RD_MOD. Alarm and warning codes are set in ALM_DATA from byte 6 in order from the most recent, and 0 is set in the bytes that are blank. Accordingly, the data in byte 6 is the latest alarm or warning code. A warning will occur and the command will be ignored in the following cases. <ul style="list-style-type: none"> -If ALM_RD_MOD is out of the range: Data setting warning 2 (A.94B) 		
4						
5						
6						
7						
8						
9						
10						
11						
12						
13						
14						
15						
16	WDT	RWDT				

* Alarm history is saved in the non-volatile memory, and will not be lost if the control power goes OFF.

(2) ALM_RD_MOD Specifications

ALM_RD_MOD	Description	Processing Time									
0	Read current alarm/warning status 10 items max. (sixth to fifteenth byte)	Within communications cycle									
1	Read alarm history (warnings and communications alarms A.E50 and A.E60 are not preserved in the history.) 10 records max. (sixth to fifteenth byte)	Within 60 ms									
2	Gets the detailed information of current alarm or warning one by one. Set the occurrence order from 0 (the latest) to 9 for the alarm index.	Within 12 m									
	<table border="1"> <thead> <tr> <th>Byte</th> <th>Command</th> <th>Response</th> </tr> </thead> <tbody> <tr> <td>6</td> <td>Alarm index</td> <td>Alarm index</td> </tr> <tr> <td>7</td> <td>0</td> <td rowspan="2">Alarm code</td> </tr> <tr> <td>8</td> <td>0</td> </tr> </tbody> </table>		Byte	Command	Response	6	Alarm index	Alarm index	7	0	Alarm code
Byte	Command	Response									
6	Alarm index	Alarm index									
7	0	Alarm code									
8	0										
3	Gets the detailed information of alarm history one by one. Set the occurrence order from 0 (the latest) to 9 for the alarm index.	Within 12 m									
	<table border="1"> <thead> <tr> <th>Byte</th> <th>Command</th> <th>Response</th> </tr> </thead> <tbody> <tr> <td>6</td> <td>Alarm index</td> <td>Alarm index</td> </tr> <tr> <td>7</td> <td>0</td> <td rowspan="2">Alarm code</td> </tr> <tr> <td>8</td> <td>0</td> </tr> </tbody> </table>		Byte	Command	Response	6	Alarm index	Alarm index	7	0	Alarm code
Byte	Command	Response									
6	Alarm index	Alarm index									
7	0	Alarm code									
8	0										

1. When ALM_RD_MOD=0 or 1

An alarm code of 1-byte length is returned.

Example) The communications error alarm A.E61 occurred after warning A.960 occurred.

1) Current warning/alarm (ALM_RD_MOD = 0)

2) Alarm history (ALM_RD_MOD = 1)

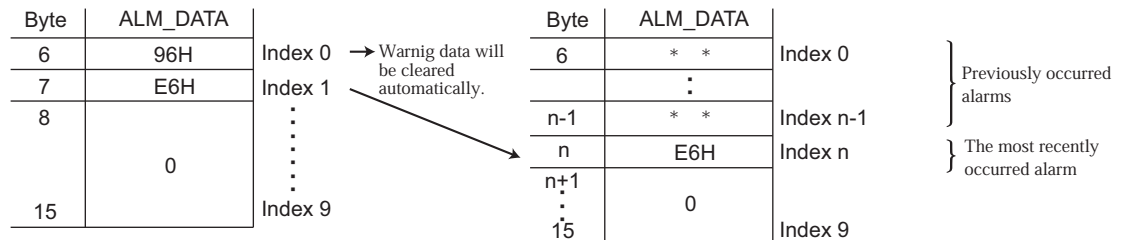

Note 1. The current warning or alarm status can be cleared by executing the ALM_CLR (ALM_CLR_MOD = 0) command.

2. The alarm history will not be cleared until the ALM_CLR(ALM_CLR_MOD = 1) command is executed.

2. When ALM_RD_MOD = 2 or 3

An alarm code of 2-byte length is returned.

If ALM_RD_MOD is set to 2 in the above example, the following alarm codes will be read out.

0x960 for alarm index 0, and

0xE61 for alarm index 1

3.16 Clear Warning or Alarm (ALM_CLR: 06H)

Send an ALM_CLR command to clear the warning/alarm status and the alarm history.

(1) Clear Alarm or Warning (ALM_CLR: 06H)

The specifications of the ALM_CLR command are described below.

Byte	ALM_CLR		Description			
	Command	Response				
1	06H	06H	Phases in which the command can be executed	Phase 2 and 3	Synchronization classification	Asynchronous command
2		ALARM	Processing time	See (2) <i>ALM_CLR_MODAL Specifications.</i>	Subcommand	Cannot be used
3		STATUS	<ul style="list-style-type: none"> Clears the followings. <ul style="list-style-type: none"> Current alarm/warning status Alarm history * A warning will occur and the command will be ignored in the following cases. <ul style="list-style-type: none"> While editing using SigmaWin or digital operator: Command warning 1 (A.95A) ALM_CLR_MODAL is out of the setting range: Data setting warning 2 (A.94B) 			
4						
5	ALM_CLR_MODAL	ALM_CLR_MODAL				
6						
7						
8						
9						
10						
11						
12						
13						
14						
15						
16	WDT	RWDT				

* Alarm history is saved in the non-volatile memory, and will not be lost if the control power goes OFF.

(2) ALM_CLR_MODAL Specifications

ALM_CLR_MODAL	Description	Processing Time
0	Clears current alarm/warning status.	Within 200 ms
1	Clears alarm history.	Within 2 s

3.17 Set Coordinate System (POS_SET: 20H)

Send a POS_SET command to set the position coordinate system.

(1) Set Coordinates (POS_SET: 20H)

The specifications of the POS_SET command are described below.

Byte	POS_SET		Description			
	Command	Response				
1	20H	20H	Phases in which the command can be executed	Phase 2 and 3	Synchronization classification	Asynchronous command
2		ALARM	Processing time	Within communications cycle	Subcommand	Cannot be used
3		STATUS	<ul style="list-style-type: none"> Sets the current position to the position specified by POS_DATA. The origin (ZPOINT) and software limit settings are enabled by setting a reference point . See (2) <i>PS_SUBCMD Specifications</i> for details on PS_SUBCMD. Specify the position (coordinates) in POS_DATA. A warning will occur and the command will be ignored in the following cases. <ul style="list-style-type: none"> - A number out of the range is set in PS_SUBCMD: Data setting warning 2 (A.94B) 			
4						
5	PS_SUBCMD	PS_SUBCMD				
6	POS_DATA	POS_DATA				
7						
8						
9						
10						
11						
12						
13						
14						
15						
16	WDT	RWDT				

(2) PS_SUBCMD Specifications

The specifications of PS_SUBCMD are described below.

D7	D6	D5	D4	D3	D2	D1	D0
REFE	0	0	0	POS_SEL			

- REFE (Reference Point Setting)
 - 0: Does not set reference point.
 - 1: Sets reference point. The coordinates will be determined and the zero point position (ZPOINT) and software limit setting will be enabled.
- POS_SEL (Coordinate system selection)
 - 3: Sets APOS (feedback position in machine coordinate system), and sets the positions of all coordinate systems (TPOS, IPOS, POS, MPOS, APOS) to POS_DATA.

3.18 Monitor and Adjust Settings (ADJ: 3EH)

Send an ADJ command to monitor and adjust settings.

(1) Adjusting (ADJ: 3EH)

The specifications of the ADJ command are described below.

Byte	ADJ		Description			
	Command	Response				
1	3EH	3EH	Phases in which the command can be executed	Phase 2 and 3	Synchronization classification	Asynchronous command
2	SUBCODE=01	ALARM	Processing time	Depends on processing	Subcommand	Cannot be used
3		STATUS	<ul style="list-style-type: none"> Use this command as SUBCODE = 01H. The SERVOPACK will be in maintenance mode. And, data monitoring and adjustment will be enabled. See (2) <i>How to Send an ADJ Command for Adjustment</i> for details on ADJ for adjustment. See (3) <i>How to Send an ADJ Command for Monitoring Data</i> for details on ADJ for monitoring data. A warning will occur and the command will be ignored in the following cases. <ul style="list-style-type: none"> While editing using SigmaWin or digital operator: Command warning 1 (A.95A) CADDRESS is out of the range: Parameter setting warning 1 (A.94A) CSIZE does not match: Parameter setting warning 4 (A.94D) CCMD and/or CDATA are out of the range: Parameter setting warning 2 (A.94B) 			
4						
5	CCMD	CANS				
6						
7	CADDRESS	CADDRESS				
8						
9	CSIZE	CSIZE/ ERRCODE				
10						
11	CDATA	RDATA				
12						
13						
14						
15						
16	WDT	RWDT				

(2) How to Send an ADJ Command for Adjustment

The table below lists the adjustments that can be executed by sending an ADJ command.

List of Executable Adjustments

Adjustment	Request Code	Preparation Before Execution	Processing Time	Execution Conditions
Normal mode	0000H	None	200 ms max.	
Parameter initialization	1005H	None	20 s max.	Initialization impossible while the servo is ON. After initialization, the power supply must be turned off and then on again.
Absolute encoder reset	1008H	Required	5 s max.	When using an incremental encoder, impossible to reset the encoder while the servo is ON.
Automatic offset adjustment of motor current detection signals	100EH	None	5 s max.	Adjustment is disabled: <ul style="list-style-type: none"> While the main circuit power supply is OFF While the servo is ON While the servomotor is running

List of Executable Adjustments (cont'd)

Adjustment	Request Code	Preparation Before Execution	Processing Time	Execution Conditions
Multiturn limit setting	1013H	Required	5 s max.	When using an incremental encoder, the setting is disabled unless A.CC0 (Multiturn limit disagreement) occurs.

ADJ Command Execution Procedure for Adjustment:

Details of Command for Adjustment

	Command	Response
CCMD/CANS	CCMD = 04H	CANS = 04H (copy of the command)
CADDRESS	Setting address	Reference address (copy of the command)
CSIZE/ ERRCODE	2 or 4	At normal reception: 0000H At error occurrence: A value other than 0
CDATA/RDATA	Setting data	Setting data (copy of the command)

- Send the following data and set the request code of the adjustment to be executed.
 CCMD = 0004H
 CADDRESS = 2000H
 CSIZE = 0002H
 CDATA = Request code of the adjustment to be executed
 When the slave station receives the command normally, CMDRDY of status field will be set to 1. Also check ERRCODE. If an error occurs, carry out the operation in step 4 to abort execution.
- For adjustment that requires a preparation process, send the following data.
 CCMD = 0004H
 CADDRESS = 2001H
 CSIZE = 0002H
 CDATA = 0002H
 When the slave station receives the command normally, CMDRDY of status field will be set to 1. Also check ERRCODE. If an error occurs, carry out the operation in step 4 to abort execution.
- Send the following data to execute adjustment.
 CCMD = 0004H
 CADDRESS = 2001H
 CSIZE = 0002H
 CDATA = 0001H
 When the slave station receives the command normally, CMDRDY of status field will be set to 1. Also check ERRCODE. If an error occurs, carry out the operation in step 4 to abort execution.
- Send the following data to abort the execution.
 CCMD = 0004H
 CADDRESS = 2000H
 CSIZE = 0002H
 CDATA = 0000H
 When the execution is aborted, CMDRDY of status field will be set to 1.

(3) How to Send an ADJ Command for Monitoring Data

The table below lists the data that can be monitored.

List of Data that Can be Monitored

Name	Reference Address	Data Size	Unit	Remarks
Motor capacity	C00FH (Lower-most) C010H (Upper-most)	2 bytes	[W]	
Motor voltage	C011H	2 bytes	[V]	

List of Data that Can be Monitored

Name	Reference Address	Data Size	Unit	Remarks
Motor rated speed	C01CH	2 bytes	Rotary motor: [$\times 10^{C01EH}$ reference value min^{-1}] Linear motor: [$\times 10^{C01EH}$ reference value mm / s]	
Motor max. speed	C01DH	2 bytes	Rotary motor: [$\times 10^{C01EH}$ reference value min^{-1}] Linear motor: [$\times 10^{C01EH}$ reference value mm / s]	
Motor speed exponent	C01EH	2 bytes	–	
Motor rated torque (force)	C01FH	2 bytes	Rotary servomotor: [$\times 10^{C021H}$ reference value N.m] Linear servomotor: [$\times 10^{C021H}$ reference value N]	
Motor torque (force) exponent	C021H	2 bytes	–	
Encoder resolution	C022H (Lower-most) C023H (Upper-most)	2 bytes	Rotary servomotor: [pulse / rev] Linear servomotor: [pulse / pitch]	Note: When fully-closed setting is enabled (Pn002.3 \neq 0), the unit is [pulse / pitch]
Maximum motor torque (force) that can be output	E701H	2 bytes	[%]	
Motor max. output speed	C027H	2 bytes	Rotary servomotor: [$\times 10^{C01EH}$ reference value min^{-1}] Linear servomotor: [$\times 10^{C01EH}$ reference value mm / s]	
Linear scale pitch	E084H	4 bytes	[$\times 10^{E086H}$ reference value pm / pitch]	For linear servomotors only
Linear scale pitch exponent	E086H	2 bytes	–	For linear servomotors only

ADJ Command Execution Procedure for Monitoring Data:

Details of Command to Monitor Data

	Command	Response
CCMD/CANS	CCMD = 03H	CANS = 03H (copy of the command)
CADDRESS	Reference address	Reference address (copy of the command)
CSIZE/ ERRCODE	– (Not required)	At normal reception: SIZE (2 or 4) At error occurant: A value other than 2 and 4
CDATA/RDATA	– (Not required)	Reference data

1. Set the reference address to be monitored, and send the ADJ command.
CCMD = 0003H
CADDRESS = Reference address
When the slave station receives the command normally, CMDRDY of status field will be see to 1. Also check ERRCODE.
2. When the command transmission is completed normally, CDATA of RSP will be read out for CSIZE to obtain the data.

Speed/Torque (Force) Data Normalization

The following data used in position, speed, or torque (force) control commands will be normalized:

Speed data: VREF, VLIM :[maximum motor speed/40000000H]

Torque (force) data: TFF/P_TLIM/N_TLIM/TLIM [maximum motor torque (force)/4000H]
 TQREF [maximum motor torque (force)/40000000H]

The maximum motor speed and maximum motor torque (force) used in the above data can be obtained by the following equations.

Maximum motor speed = C027H reference value $\times 10^{C01EH}$ reference value [Rotational servomotor: min^{-1} ,
Linear servomotor: mm/s]

Maximum motor torque (force) = C01FH reference value $\times 10^{C021H}$ reference value $\times E071H$ reference
value/100 [Rotational servomotor: N.m, Linear servomotor: N]

Motion Commands for Operation

This chapter describes the MECHATROLINK-II commands needed to control motions.

4.1 Stop Motion (HOLD: 25H)	4-3
4.2 Set Latch Mode (LTMOD_ON: 28H)	4-5
4.3 Release Latch Mode (LTMOD_OFF: 29H)	4-8
4.4 Interpolation Feeding (INTERPOLATE: 34H)	4-9
4.5 Positioning (POSING: 35H)	4-11
4.6 Constant Speed Feeding (FEED: 36H)	4-13
4.7 Interpolation Feeding with Position Detection (LATCH: 38H)	4-15
4.8 External Input Positioning (EX_POSING: 39H)	4-17
4.9 Homing (ZRET: 3AH)	4-19
4.10 Velocity Control (VELCTRL: 3CH)	4-21
4.11 Torque (Force) Control (TRQCTRL: 3DH)	4-23

The motion commands described in this chapter are listed below.

(1) Motion Commands

The motion commands are listed below.

	Items	Command to Send	Description
Position Control	Stop Motion	HOLD	From current motion status, performs a deceleration stop in the set pattern and positioning.
	Set Latch Mode	LTMOD_ON	Requests the latch mode. If a latch signal is input in latch mode, position latching will be performed.
	Release Latch Mode	LTMOD_OFF	Releases the latch mode.
	Interpolation Feed	INTERPOLATE	Starts interpolation feeding.
	Positioning	POSING	Performs positioning to the target position (TPOS) at the target speed (TSPD).
	Constant Speed Feed	FEED	Performs constant speed feeding in position by position control.
	Interpolation Feeding with Position Detection	LATCH	Performs interpolation feeding and latches the position when an external signal is input.
	External Input Positioning	EX_POSING	Moves toward the target position (TPOS) at the target speed (TSPD). When a latch signal is input midway, positioning is performed according to the final travel distance for external position specified in the parameter from the latch signal input position.
	Homing	ZRET	Performs a homing.
Speed Control	Velocity Control	VELCTRL	Controls speed. (The SERVOPACK does not perform position control, but directly controls the speed of the speed loop.)
Torque (Force) Control	Torque (Force) Control	TRQCTRL	Controls torque (force). (The SERVOPACK does not perform position control and speed control, but directly performs torque (force) control.)

4.1 Stop Motion (HOLD: 25H)

(1) HOLD Command (25H)

The HOLD command is used to perform a deceleration to stop from the current run status, at a deceleration ratio specified by the parameter for positioning.

Byte	HOLD		Description			
	Command	Response				
1	25H	25H	Phases in which the command can be executed	Phase 2 and 3	Synchronization classification	Asynchronous command
2		ALARM	Processing time	Within communications cycle	Subcommand	Cannot be used
3	OPTION	STATUS	<ul style="list-style-type: none"> From current motion status, performs a deceleration stop at a deceleration ratio specified by the parameter for positioning. Use DEN (output complete) to confirm position data output completion. Option field can be used. This command will cancel the latch processing specified by the LATCH or EX_POSING command. This command will cancel ZRET latch processing and ZRET homing. Upon completion of execution of this command, the reference position (POS) must be read, and the controller coordinate system must be setup. The stopping method can be selected using HOLD_MOD. <ul style="list-style-type: none"> 0 = Stop according to the 1st or 2nd linear deceleration constant. 1 = Stop immediately (stop reference output) 2 = Stop according to the linear deceleration constant for stopping 			
4						
5	HOLD_MOD	MONITOR1				
6						
7						
8						
9						
10						
11						
12						
13	SEL_MON1/2	SEL_MON1/2				
14		IO_MON				
15						
16	WDT	RWDT				
17	Subcommand area	Subcommand area				
18						
19						
20						
21						
22						
23						
24						
25						
26						
27						
28						
29						

(2) Related Parameters

Deceleration is specified by the following parameters.

Parameter No.	Name
Pn80D (Pn83A)	1st Linear Deceleration Constant
Pn80E (Pn83C)	2nd Linear Deceleration Constant
Pn80F (Pn83E)	Deceleration Constant Switching Speed
Pn827 (Pn840)	Linear Deceleration Constant for Stopping

Parameter number in parenthesis is when Pn833 = 1.

4.2 Set Latch Mode (LTMOD_ON: 28H)

(1) LTMOD_ON Command (28H)

The LTMOD_ON command is used to start latching the external signal input position data. Execution on the LTMOD_ON command allows latch operation while a command such as POSING and VELCTRL is being executed.

Byte	LTMOD_ON		Description			
	Command	Response				
1	28H	28H	Phases in which the command can be executed	Phase 2 and 3	Synchronization classification	Asynchronous command
2	LT_SGNL	ALARM	Processing time	Within communications cycle	Subcommand	Can be used
3		STATUS	<ul style="list-style-type: none"> Starts latch operation. Use LT_MOD to switch the latch mode: <ul style="list-style-type: none"> = 0: Normal latch mode (Latches the position data when a signal selected by LT_SGNL is input) = 1: Continuous latch (Latches the position data according to the values set in Pn850 to Pn853) Note: When LT_MOD ≠ 1, the normal latch mode is always selected. <ul style="list-style-type: none"> When CMDRDY = 1, this command has been received. Confirm that L_CMP of status field is set to 1 at completion of latching. When there is monitor data such as SMON and POSING appended to the command response, LPOS is forcefully returned to MONITOR 2 for one communications cycle. When there is no monitor data such as PRM_RD or ALM_RD appended to the command response, confirm that L_CMP of status field is set 1, then use a command that has monitor data such as SMON in the response and select LPOS to confirm. A warning will occur and the command will not be executed. <ul style="list-style-type: none"> Interference with another latch mode command (If this command is sent while another latch mode command such as EX_POSING, LATCH, ZRET, and SVCTRL is being executed): Command warning 4 (A.95D) LT_MOD = 1 and Pn850 = 0: Data setting warning 5 (A.94E) Latch time lag <ul style="list-style-type: none"> From reception of the command to latching start: 250ms max. From completion of latching to transmission of a response: One communications cycle max. 			
4						
5	LT_MOD	MONITOR1				
6						
7						
8						
9						
10						
11		MONITOR2				
12						
13	SEL_MON1/2	SEL_MON1/2				
14		IO_MON				
15						
16	WDT	RWDT				
17	Subcommand area	Subcommand area				
18						
19						
20						
21						
22						
23						
24						
25						
26						
27						
28						
29						

(2) Normal Latch Mode

In normal latch mode, the latch operation is started by sending an LTMOD_ON command, and it is completed when the input position of the latch signal LT_SGNL specified in the LTMOD_ON command is latched. To restart the latch operation, send the LTMOD_OFF command once, then send the LTMODE_ON command again. Use LT_MOD in the LTMOD_ON command to select either normal or continuous latch mode.

(3) Continuous Latch Mode

This function sequentially latches the input positions of sequence signal 1 to sequence signal n ($n = 1$ to 8) for a specified number of times. The continuous latch operation can be aborted by executing the `LTMOD_OFF` command. This function can shorten the time between latch completion and the start of the next latch, and enables sequential latch operations at high speed.

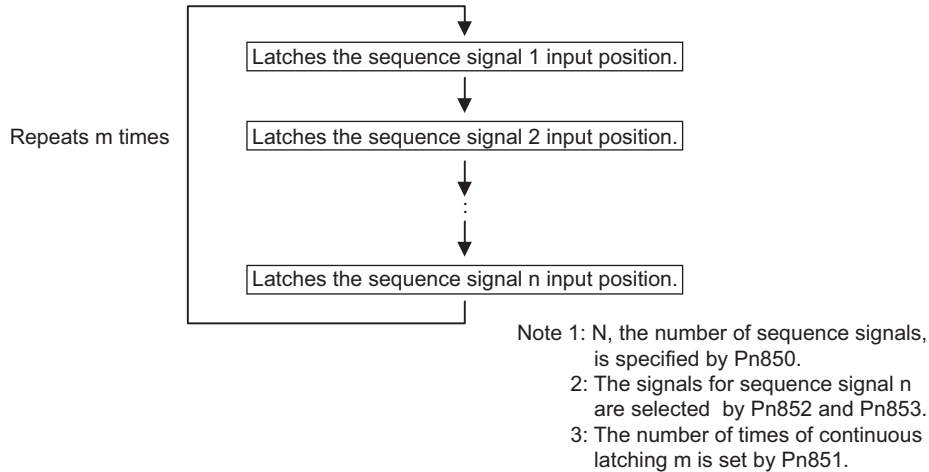

[How to Start and Stop Continuous Latch Operation]

Set the following parameters, and then set `LT_MOD` to 1 to execute the `LTMOD_ON` command. The continuous latch operation will start. To abort the operation, execute the `LTMOD_OFF` command.

Pn850: Latch Sequence Number n

Pn851: Continuous Latch Count m (When $m = 0$, the continuous latch operation will be infinitely repeated.)

Pn852: Latch Sequence Signal 1 to 4 Setting

Pn853: Latch Sequence Signal 5 to 8 Setting

Note: If the `LTMOD_ON` command is executed by setting Pn850 to 0 and `LT_MOD` to 1, the latch mode error warning (A.94E) will occur and the latch operation will not start.

[Latch Status]

Latch completion can be confirmed by the following status.

[STATUS Field: The 3rd and 4th byte]

`L_CMP` (D10): `L_CMP` is set to 1 for one communications cycle every time the external signal is input.

[EX_STATUS Field: The 28th and 29th byte]

`L_SEQ_NO` (D8-D11): The latch sequence signal number (value n) at latch completion

`L_CMP_CNT` (D0-D7): The continuous latch count (value m)
(Added at completion of position latch when the latch sequence signal n is input.)

Note: `LPOS` is forcibly output to MONITOR 2 for one communications cycle while `L_CMP = 1` every time the external signal is input.

[Latched Position Data]

The latest latched position data at completion of latching can be obtained by using the following monitor.

Name	Code	Remarks
Feedback Latch Position	LPOS	The latest latch signal input position

The previously latched position data can be obtained by using the following option monitor.

Name	Code	Option Monitor Selection (Pn824 and Pn825)
Option Monitor 1 and 2	OMN1, 2	80H: Previous latch signal input position

(4) LT_SGNL Specifications

The latch signal can be specified by setting the lowermost two bits of the 2nd byte LT_SGNL in the command as shown below.

D7	D6	D5	D4	D3	D2	D1	D0
0	0	0	0	0	0	LT_SGNL	

D1	D0	Latch Signal	Signal Details
0	0	Phase C	Encoder origin signal
0	1	EXT1	External input signal 1
1	0	EXT2	External input signal 2
1	1	EXT3	External input signal 3

(5) Related Parameters

The parameters related to latch operation are listed below.

Parameter No.	Name
Pn820	Forward Latching Allowable Area
Pn822	Reverse Latching Allowable Area
Pn850	Latch Sequence Number
Pn851	Continuous Latch Count
Pn852 and Pn853	Latch Sequence Signal Setting

4.3 Release Latch Mode (LTMOD_OFF: 29H)

(1) LTMOD_OFF Command (29H)

The LTMOD_OFF command is used to release the latch mode.

Byte	LTMOD_OFF		Description							
	Command	Response								
1	29H	29H	Phases in which the command can be executed	Phase 2 and 3	Synchronization classification	Asynchronous command				
2		ALARM	Processing time	Within communications cycle	Subcommand	Can be used				
3		STATUS	<ul style="list-style-type: none"> Check that CMDRDY is 1 to confirm that this command has been received. It takes 250 μs max. to release the latch mode. This command cannot be used while LATCH, ZRET, EX_POSING, or SVCTRL command is being executed. If used, the command warning 4 (A.95D) will occur. 							
4										
5										
6										
7		MONITOR1								
8										
9										
10										
11		MONITOR2								
12										
13		SEL_MON1/2					SEL_MON1/2			
14		IO_MON								
15										
16	WDT	RWDT								
17	Subcommand area	Subcommand area								
18										
19										
20										
21										
22										
23										
24										
25										
26										
27										
28										
29										

4.4 Interpolation Feeding (INTERPOLATE: 34H)

(1) INTERPOLATE Command (34H)

The INTERPOLATE command is used to start interpolation feeding. Speed feed forward and torque (force) feed forward can be specified simultaneously.

Byte	INTERPOLATE		Description			
	Command	Response				
1	34H	34H	Phases in which the command can be executed	Phase 3	Synchronization classification	Asynchronous command
2		ALARM	Processing time	Within communications cycle	Subcommand	Can be used
3	OPTION	STATUS	<ul style="list-style-type: none"> OPTION field can be selected. Interpolation feeding is performed by specifying the target position (TPOS) every communications cycle. The target position (TPOS) is a signed 4-byte data. Note: The target position is not an incremental value (travel amount), but the absolute position in the reference coordinate system. The speed feed forward (VEF [reference units/s]) is a signed 4-byte data. Either torque (force) feed forward (TFF) or torque (force) limit (TLIM) can be used. It can be selected by setting Pn81F and Pn002. <ul style="list-style-type: none"> TFF setting range: A signed 2-byte data [maximum motor torque (force)/ 4000H] Use the ADJ command to obtain the maximum motor torque (force). TLIM setting range: 0 to 4000H [maximum motor torque (force)/ 4000H] (If a value between 4000H and FFFFH is set, the maximum motor torque (force) will be applied as the limit. Use DEN (output complete) to confirm the completion of position reference output. When a command in execution is switched to another command, the feed forward value (VFF or TFF) will be cleared. A warning will occur and the command will not be executed in the following cases. <ul style="list-style-type: none"> If this command is used in communications phase other than phase 3: Command warning 1 (A.95A) If this command is sent while the servo is OFF: Command warning 1 (A.95A) The travel amount (Target position (TPOS) - Current position (IPOS)) exceeds the limit value: Data setting warning 2 (A.94B) 			
4						
5	TPOS	MONITOR1				
6						
7						
8						
9	VFF	MONITOR2				
10						
11						
12						
13	SEL_MON1/2	SEL_MON1/2				
14	TFF/TLIM	IO_MON				
15						
16	WDT	RWDT				
17	Subcommand area	Subcommand area				
18						
19						
20						
21						
22						
23						
24						
25						
26						
27						
28						
29						

(2) Related Parameters

Either torque (force) feed forward (TFF) or torque (force) limit (TLIM) can be selected by setting the following parameters.

Parameter No.	Set Value	Meaning
Pn81F	n.□□1□	Enables the torque (force) feed forward (TFF).
Pn002	n.□□□2	
Pn81F	n.□□1□	Enables forward/reverse torque (force) limit using TLIM.
Pn002	n.□□□1	
Pn81F	n.□□1□	When P_CL of OPTION field is set to 1: Uses TLIM as positive torque (force) limit.
Pn002	n.□□□3	When N_CL of OPTION field is set to 1: Uses TLIM as negative torque (force) limit.

4.5 Positioning (POSING: 35H)

(1) POSING Command (35H)

The POSING command is used to start positioning to the target position (TPOS) at the target speed (TSPD).

Byte	POSING		Description			
	Command	Response				
1	35H	35H	Phases in which the command can be executed	Phase 2 and 3	Synchronization classification	Asynchronous command
2		ALARM	Processing time	Within communications cycle	Subcommand	Can be used
3	OPTION	STATUS	<ul style="list-style-type: none"> OPTION field can be selected. The target position (TPOS) is a signed 4-byte data. It is sent by using an absolute position in the reference coordinate system. Set the target position (TPOS) so that the movement distance (TPOS - IPOS) is 2,147,483,647 (= $2^{31}-1$) or less. Set the target speed (TSPD) to a value between 0 and the motor max. speed [reference unit/s]. Changes can be made to the target position and target speed during movement. The torque (force) limit (TLIM) can be used by setting Pn81F and Pn002. <ul style="list-style-type: none"> TLIM setting range: 0 to 4000H [maximum motor torque (force)/4000H] If TLIM is set to a value between 4000H and FFFFH, the maximum motor torque (force) will be applied as the limit. Use the ADJ command to obtain the maximum motor torque (force). Use DEN (output complete) to confirm the completion of position reference output. A warning will occur and the command will be ignored in the following case. <ul style="list-style-type: none"> This command is used while the servo is OFF: Command warning 1 (A.95A) The travel amount (Target position (TPOS) - Current position (IPOS)) exceeds the limit: Data setting warning 2 (A.94B) The target speed (TSPD) exceeds the limit: Data setting warning 2 (A.94B) 			
4						
5	TPOS	MONITOR1				
6						
7						
8						
9	TSPD	MONITOR2				
10						
11						
12						
13	SEL_MON1/2	SEL_MON1/2				
14	TLIM	IO_MON				
15						
16	WDT	RWDT				
17	Subcommand area	Subcommand area				
18						
19						
20						
21						
22						
23						
24						
25						
26						
27						
28						
29						

Positioning will be performed as illustrated below.

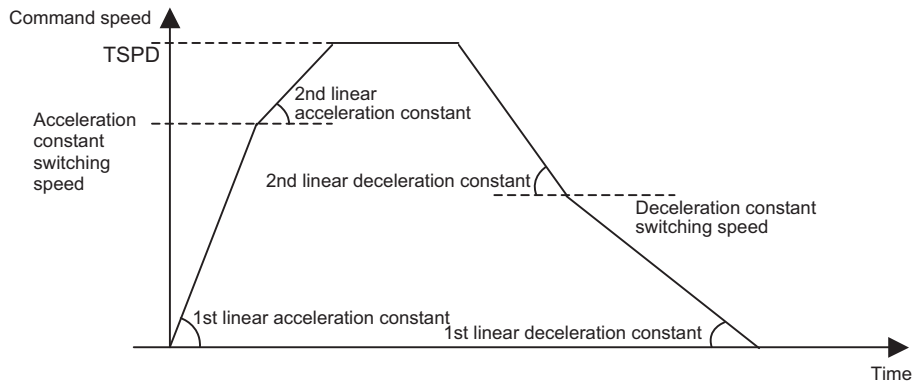

(2) Related Parameters

The parameters related to the execution of POSING command are listed below.

Parameter number in parentheses is when Pn833=1.

Parameter No.	Name
Pn80A (Pn834)	1st Linear Acceleration Constant
Pn80B (Pn836)	2nd Linear Acceleration Constant
Pn80C (Pn838)	Acceleration Constant Switching Speed
Pn80D (Pn83A)	1st Linear Deceleration Constant
Pn80E (Pn83C)	2nd Linear Deceleration Constant
Pn80F (Pn83E)	Deceleration Constant Switching Speed
Pn81F	Position Control Command TFF/TLIM Function Allocation
Pn002	Torque (Force) Reference Option During Speed/Position Control

Set the parameters as shown below to use TLIM.

Parameter No.	Set Value	Meaning
Pn81F	n.□□1□	Enables forward/reverse torque (force) limit using TLIM.
Pn002	n.□□□1	
Pn81F	n.□□1□	When P_CL of OPTION field is set to 1: Uses TLIM as positive torque (force) limit.
Pn002	n.□□□3	When N_CL of OPTION field is set to 1: Uses TLIM as negative torque (force) limit

4.6 Constant Speed Feeding (FEED: 36H)

(1) FEED Command (36H)

The FEED command is used to start constant speed feeding at the specified target speed (TSPD) by position control.

Use Stop Motion command (HOLD: 25H) to stop constant speed feeding executed by this command.

Byte	FEED		Description				
	Command	Response					
1	36H	36H	Phases in which the command can be executed	Phase 2 and 3	Synchronization classification	Asynchronous command	
2		ALARM	Processing time	Within communications cycle	Subcommand	Can be used	
3	OPTION	STATUS	<ul style="list-style-type: none"> OPTION field can be selected. The target speed (TSPD) is a signed 4-byte data. The feeding direction is determined by the sign. Constant speed feeding is carried out at the specified target speed. TSPD setting range: From the negative (-) motor max. speed to the positive (+) motor max. speed [reference unit/s] Changes can be made to the target speed during movement. Change the target speed as required and send this command. The torque (force) limit (TLIM) can be used by setting Pn81F and Pn002. - TLIM setting range: 0 to 4000H [maximum motor torque (force)/4000H] If TLIM is set to a value between 4000H and FFFFH, the maximum motor torque (force) will be applied as the limit. Use the ADJ command to obtain the maximum motor torque (force). Use the DEN (output complete) to confirm the completion of position reference output. A warning will occur and the command will not be executed in the following cases. <ul style="list-style-type: none"> The command is used while the servo is OFF: Command warning 1 (A.95A) The target speed (TSPD) exceeds the limit: Data setting warning 2 (A.94B) 				
4							
5							MONITOR1
6							
7							
8							
9	TSPD	MONITOR2					
10							
11							
12							
13	SEL_MON1/2	SEL_MON1/2					
14	TLIM	IO_MON					
15							
16	WDT	RWDT					
17	Subcommand area	Subcommand area					
18							
19							
20							
21							
22							
23							
24							
25							
26							
27							
28							
29							

Constant speed feeding is performed as illustrated below.

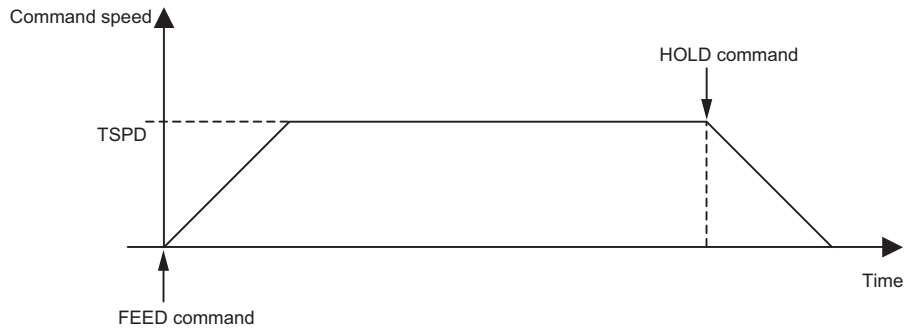

(2) Related Parameters

The parameters related to the execution of this command are listed below.

Parameter number in parentheses is when Pn833 = 1.

Parameter No.	Name
Pn80A (Pn834)	1st Linear Acceleration Constant
Pn80B (Pn836)	2nd Linear Acceleration Constant
Pn80C (Pn838)	Acceleration Constant Switching Speed
Pn81F	Position Control Command TFF/TLIM Function Allocation
Pn002	Torque (Force) Reference Option During Speed/Position Control

Set the parameters as shown below to use TLIM.

Parameter No.	Set Value	Meaning
Pn81F	□□1□	Enables torque (force) limit (TLIM).
Pn002	n.□□□1 or n.□□□3	
Pn81F	n.□□1□	When P_CL of OPTION field is set to 1: Uses TLIM as positive torque (force) limit.
Pn002	n.□□□3	When N_CL of OPTION field is set to 1: Uses TLIM as negative torque (force) limit.

4.7 Interpolation Feeding with Position Detection (LATCH: 38H)

(1) LATCH Command (38H)

The LATCH command is used to start interpolation feeding and to latch the current position when the external signal is input during positioning.

Speed feed forward, torque (force) feed forward, and torque (force) limit can be applied.

Byte	LATCH		Description					
	Command	Response						
1	38H	38H	Phases in which the command can be executed	Phase 3	Synchronization classification	Asynchronous command		
2	LT_SGNL	ALARM	Processing time	Within communications cycle	Subcommand	Can be used		
3	OPTION	STATUS	<ul style="list-style-type: none"> Use LT_SGNL to select the latch signal. The position data when the latch signal is input is stored in the feedback latch position (LPOS) and is forcibly output to MONITOR2 for one communications cycle. OPTION field can be used. Interpolation feeding is performed by specifying the target position (TPOS) every communications cycle. The target position (TPOS) is a signed 4-byte data. Note: The target position is not an incremental value (travel amount), but the absolute position in the reference coordinate system. The speed feed forward (VEF [reference units/s]) is a signed 4-byte data. Either torque (force) feed forward (TFF) or torque (force) limit (TLIM) can be used. It can be selected by setting Pn81F and Pn002. <ul style="list-style-type: none"> TLIM setting range: 0 to 4000H [maximum motor torque (force)/4000H] (If a value between 4000H and FFFFH is set, the maximum motor torque (force) will be applied as the limit.) Use the ADJ command to obtain the maximum motor torque (force). TFF setting range: A signed 2-byte data [maximum motor torque (force)/4000H] Use DEN (output complete) to confirm the completion of position reference output. When a command in execution is switched to another command, the feed forward values (VFF and TFF) will be cleared. A warning will occur and the command will not be executed in the following cases. <ul style="list-style-type: none"> The command is used in a phase other than phase 3: Command warning 1 (A.95A) The command is sent while the servo is OFF: Command warning 1 (A.95A) The travel amount (Target position (TPOS) - Current position (IPOS)) exceeds the limit: Data setting warning 2 (A.94B) Latch time lag <ul style="list-style-type: none"> From reception of the command to latching start: 250 μs max. From completion of latching to transmission of a response: One communications cycle max. 					
4								
5	TPOS	MONITOR1						
6								
7								
8								
9	VFF	MONITOR2						
10								
11								
12								
13	SEL_MON1/2	SEL_MON1/2						
14	TFF/TLIM	IO_MON						
15								
16	WDT	RWDT						
17	Subcommand area	Subcommand area						
18								
19								
20								
21								
22								
23								
24								
25								
26								
27								
28								
29								

(2) Related Parameters

The parameters related to the execution of LATCH command are listed below.

Parameter No.	Name
Pn820	Forward Latching Allowable Area
Pn822	Reverse Latching Allowable Area
Pn81F	Position Control Command TFF/TLIM Function Allocation
Pn002	Torque (Force) Reference Option during Speed/Position Control

Either torque (force) feed forward (TFF) or torque (force) limit (TLIM) can be selected by setting the following parameters.

Parameter No.	Set Value	Meaning
Pn81F	n.□□1□	Enables the torque (force) feed forward (TFF).
Pn002	n.□□□2	
Pn81F	n.□□1□	Enables forward/reverse torque (force) limit using TLIM.
Pn002	n.□□□1	
Pn81F	n.□□1□	When P_CL of OPTION field is set to 1: Uses TLIM as positive torque (force) limit.
Pn002	n.□□□3	When N_CL of OPTION field is set to 1: Uses TLIM as negative torque (force) limit.

4.8 External Input Positioning (EX_POSING: 39H)

(1) EX_POSING Command (39H)

The EX_POSING command is used to start positioning to the target position (TPOS) at the target speed (TSPD). When a latch signal is input midway, positioning is performed according to the final travel distance for external positioning from the latch signal input position. When no latch signal is input, positioning is performed for the target position (TPOS).

Byte	EX_POSING		Description			
	Command	Response				
1	39H	39H	Phases in which the command can be executed	Phase 2 and 3	Synchronization classification	Asynchronous command
2	LT_SGNL	ALARM	Processing time	Within communications cycle	Subcommand	Can be used
3	OPTION	STATUS	<ul style="list-style-type: none"> Use LT_SGNL to select the latch signal. When the latch signal is input, positioning is performed according to the final travel distance for external positioning specified in Pn814 from the latch signal input position. And, the latch signal input position is stored in the feedback latch position (LPOS) and is forcibly output to MONITOR2 for one communications cycle. When no latch signal is input, positioning is performed for the specified target position (TPOS). OPTION field can be used. The target position (TPOS) is a signed 4-byte data, and the absolute position in reference coordinate system. Set the target position (TPOS) so that the travel distance (TPOS - IPOS) is a value of 31 bits (24...) or less. The target speed (TSPD) is an unsigned 4-byte data. Set a value in the range between 0 and the motor max. speed [reference unit/s]. The target position and target speed can be changed during positioning executed by this command. However, any change in the target position and/or target speed after the latch signal input will be invalid. The torque (force) limit (TLIM) can be used by setting Pn81F and Pn002. <ul style="list-style-type: none"> TLIM setting range: 0 to 4000H [maximum motor torque (force)/4000H] If a value between 4000H and FFFFH is set, the maximum motor torque (force) will be applied as the limit. Use the ADJ command to obtain the maximum motor torque (force). Use DEN (output complete) to confirm the completion of position reference output. When the command in execution is switched from this command to another command, latching will be cancelled and positioning will be performed for the specified target position (TPOS). A warning will occur and the command will not be executed in the following cases. <ul style="list-style-type: none"> This command is used when the servo is OFF: Command warning 1 (A.95A) The target speed (TSPD) exceeds the limit: Data setting warning 2 (A.94B) 			
4						
5	TPOS	MONITOR1				
6						
7						
8						
9	TSPD	MONITOR2				
10						
11						
12						
13	SEL_MON1/2	SEL_MON1/2				
14	TLIM	IO_MON				
15						
16	WDT	RWDT				
17	Subcommand area	Subcommand area				
18						
19						
20						
21						
22						
23						
24						
25						
26						
27						
28						
29						

(2) Operation

The operation executed by EX_POSING command is illustrated below.

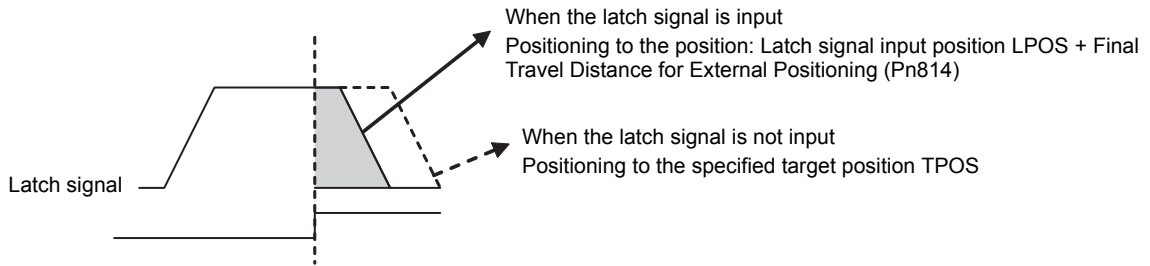

(3) Related Parameters

The parameters related to the execution of EX_POSING command are listed below.

Parameter number in parentheses is when Pn833 = 1.

Parameter No.	Name	Parameter No.	Name
Pn80A (Pn834)	1st Linear Acceleration Constant	Pn80F (Pn83E)	Deceleration Constant Switching Speed
Pn80B (Pn836)	2nd Linear Acceleration Constant	Pn814	Final Travel Distance for External Positioning
Pn80C (Pn838)	Acceleration Constant Switching Speed	Pn820	Forward Latching Allowable Area
Pn80D (Pn83A)	1st Linear Deceleration Constant	Pn822	Reverse Latching Allowable Area
Pn80E (Pn83C)	2nd Linear Deceleration Constant	Pn81F	Position Control Command TLIM Function Allocation
		Pn002	Torque (Force) Reference Option during Speed/Position Control

Set the parameters as shown below to use TLIM.

Parameter No.	Set Value	Meaning
Pn81F	n.□□1□	Enables positive/negative torque (force) limit (TLIM).
Pn002	n.□□□1	
Pn81F	n.□□1□	When P_CL of OPTION field is set to 1: Uses TLIM as positive torque (force) limit.
Pn002	n.□□□3	When N_CL of OPTION field is set to 1: Uses TLIM as negative torque (force) limit.

4.9 Homing (ZRET: 3AH)

(1) ZRET Command (3AH)

The ZRET command is used to perform homing motion in the following sequence.

1. Accelerates to the target speed (TSPD) in the direction specified in Pn816 (Homing Direction).
2. Decelerates to the homing approach speed 1 (Pn817) at the DEC = 1.
3. Latch operation will start at the DEC = 0.
4. When a latch signal is input, positioning is performed to define the target position at the homing approach speed 2 (Pn818). The target position is calculated by adding the final travel distance for homing (Pn819). After the completion of positioning, the coordinate system is set so that the position reached is 0.

Byte	ZRET		Description			
	Command	Response				
1	3AH	3AH	Phases in which the command can be executed	Phase 2 and 3	Synchronization classification	Asynchronous command
2	LT_SGNL	ALARM	Processing time	Within communications cycle	Subcommand	Can be used
3	OPTION	STATUS	<ul style="list-style-type: none"> Use LT_SGNL to select the latch signal. When the latch signal is input, positioning is performed to define the target position at the homing approach speed 2 (Pn818). The target position is calculated by adding the homing final travel distance (Pn819). The position data is recorded as the feedback latch position (LPOS) of the machine coordinate system, and the LPOS will forcibly be indicated as the MONITOR2 for one communications cycle. When the latch signal is input, L_CMP of STATUS field is set to 1, and then reset to 0 at the completion of homing. Therefore, when the homing final travel distance is short, the duration L_CMP = 1 is too short so that the status L_CMP = 1 can not be confirmed. OPTION field can be used. Set the target speed (TSPD) to a value in the range between 0 and the motor max. speed [reference unit/s]. The target speed during motion can be changed until DEC is input. The torque (force) limit (TLIM) can be used by setting Pn81F and Pn002. <ul style="list-style-type: none"> TLIM setting range: 0 to 4000H [maximum motor torque (force/4000H)] If a value between 4000H and FFFFH is set, the maximum motor torque will be applied as the limit. Use the ADJ command to obtain the maximum motor torque (force). Use DEN (output complete) and ZPOINT (home position) to confirm the completion of position reference output. If any of the following commands is received during execution of ZRET command, homing motion will be interrupted. DISCONNECT, SYNC_SET, CONFIG, HOLD, SV_OFF, INTERPOLATE, POSING, FEED, LATCH, EX_POSING, VELCTRL, TRQCTRL, SVCTRL When a command other than the above commands is received, homing operation will continue. A warning will occur and the command will be ignored in the following cases. <ul style="list-style-type: none"> This command is used while the servo is OFF.: Command warning 1 (A.95A) The target speed (TSPD) exceeds the limit: Data setting warning 2 (A.94B) 			
4						
5						
6						
7	MONITOR1					
8						
9						
10						
11	TSPD	MONITOR2				
12						
13						
14	SEL_MON1/2	SEL_MON1/2				
15	TLIM	IO_MON				
16	WDT	RWDT				
17	Subcommand area	Subcommand area				
18						
19						
20						
21						
22						
23						
24						
25						
26						
27						
28						
29						

(2) Operation

The motion executed by ZRET command is illustrated below.

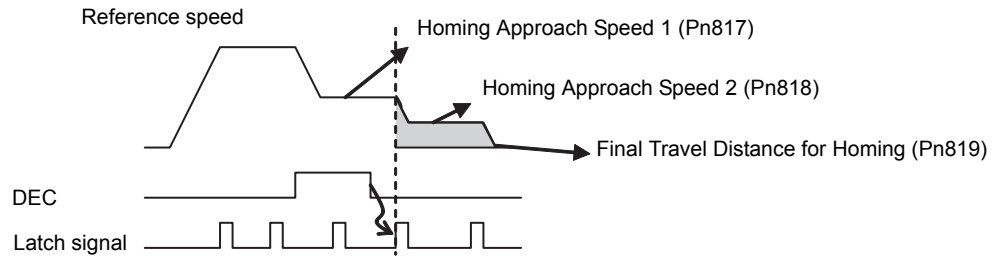

(3) Related Parameters

The parameters related to ZRET command are listed below.

Parameter number in parentheses is when Pn833 = 1.

Parameter No.	Name	Parameter No.	Name
Pn816	Homing Direction	Pn80A (Pn834)	1st Linear Acceleration Constant
Pn817	Homing Approach Speed 1	Pn80B (Pn836)	2nd Linear Acceleration Constant
Pn818	Homing Approach Speed 2	Pn80C (Pn838)	Acceleration Constant Switching Speed
Pn819	Final Travel Distance for Homing	Pn80D (Pn83A)	1st Linear Deceleration Constant
Pn820	Forward Latching Allowable Area	Pn80E (Pn83C)	2nd Linear Deceleration Constant
Pn822	Reverse Latching Allowable Area	Pn80F (Pn83E)	Deceleration Constant Switching Speed
Pn002	Torque (Force) Reference Option during Speed/Position Control	Pn81F	Position Control Command TLIM Function Allocation

Set the parameters as shown below to use TLIM.

Parameter No.	Set Value	Meaning
Pn81F	n.□□1□	Enables positive/negative torque (force) limit (TLIM).
Pn002	n.□□□1	
Pn81F	n.□□1□	When P_CL of OPTION field is set to 1: Uses TLIM as positive torque (force) limit.
Pn002	n.□□□3	When N_CL of OPTION field is set to 1: Uses TLIM as negative torque (force) limit.

4.10 Velocity Control (VELCTRL: 3CH)

(1) VELCTRL Command (3CH)

The VELCTRL command is used to control speed. (The Servo does not perform position control, but directly controls the speed of the speed loop.)

Byte	VELCTRL		Description			
	Command	Response				
1	3CH	3CH	Phases in which the command can be executed	Phase 2 and 3	Synchronization classification	Asynchronous command
2		ALARM	Processing time	Within communications cycle	Subcommand	Can be used
3	OPTION	STATUS	<ul style="list-style-type: none"> OPTION field can be used. VREF is a speed reference and has a signed 4-byte data. The unit for speed reference is [maximum motor speed/40000000H]. The direction is specified by the sign. Soft-start function can be used. See (2)Soft Start Function on the next page for details on soft-start. Either torque (force) limit (P_TLIM, N_TLIM) or torque (force) feed forward (TFF) can be used. Use Pn002 to select. <ul style="list-style-type: none"> TLIM setting range: 0 to 4000H [maximum motor torque (force)/4000H] (If a value between 4000H to FFFFH is set, the maximum motor torque (force) will be applied as the limit. Use the ADJ command to obtain the maximum motor torque (force). TFF setting range: A signed 2-byte data [maximum motor torque (force)/4000H] During execution of this command, the following bits for STATUS are allocated. <ul style="list-style-type: none"> D8: ZSPD (zero speed bit) <ul style="list-style-type: none"> 0: Zero speed not detected 1: Zero speed detected D7: V_CMP (speed coincidence bit) <ul style="list-style-type: none"> 0: Speed coincidence not detected 1: Speed coincidence detected Monitor (MONITOR 1, 2, 3, 4) <ul style="list-style-type: none"> The units for TSPD, CSPD, and FSDP is [maximum motor speed / 40000000H]. 			
4						
5	P_TLIM /TFF	MONITOR1				
6						
7	N_TLIM	MONITOR2				
8						
9	VREF	MONITOR2				
10						
11						
12						
13	SEL_MON1/2	SEL_MON1/2				
14		IO_MON				
15						
16	WDT	RWDT				
17	Subcommand area	Subcommand area				
18						
19						
20						
21						
22						
23						
24						
25						
26						
27						
28						
29						

(2) Soft Start Function

The soft start function converts input speed references from sudden step progression to steady diagonal progression. Set the acceleration speed and deceleration speed in the following parameters.

Use this function to achieve a smooth speed control in speed control mode (including internal set speed selection).

Pn305	Soft Start Acceleration Time: Time of period the motor speed reaches the maximum from zero (the stop status)			
	Setting Range	Unit	Factory Setting	When Enabled
	0 to 10000	1 ms	0	Immediately
Pn306	Soft Start Deceleration Time: Time of period the motor speed decreases to zero (stop status) from the maximum.			
	Setting Range	Unit	Factory Setting	When Enabled
	0 to 10000	1 ms	0	Immediately

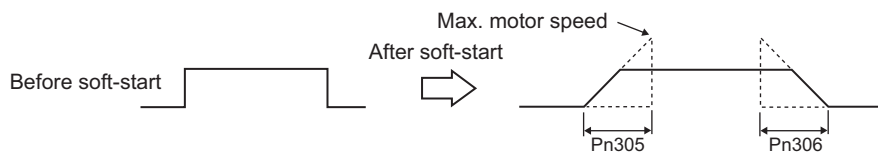

Note: For normal speed control, set Pn305 and Pn306 to 0 (factory setting).

(3) Torque (Force) Reference Option

The settings of the parameters related to the torque (force) reference option for VELCTRL command are listed below.

Parameter	Description
n.□□□0	The set values of P_TLIM and N_TLIM are invalid. (factory setting)
n.□□□1	Uses the set value of P_TLIM/N_TLIM as forward/reverse torque (force) limit.
n.□□□2	Uses TFF as the torque (force) feed forward. Set N_TLIM to 0.
n.□□□3	When P_CL of OPTION field is set to 1, uses P_TLIM as the torque (force) limit. When N_CL of OPTION field is set to 1, uses N_TLIM as the torque (force) limit.

4.11 Torque (Force) Control (TRQCTRL: 3DH)

(1) TRQCTRL (3DH)

The TRQCTRL command is used to control torque (force). (The Servo does not perform position control and speed control, but directly performs torque (force) control.)

Byte	TRQCTRL		Description			
	Command	Response				
1	3DH	3DH	Phases in which the command can be executed	Phase 2 and 3	Synchronization classification	Asynchronous command
2		ALARM	Processing time	Within communications cycle	Subcommand	Can be used
3	OPTION	STATUS	<ul style="list-style-type: none"> OPTION field can be used. VLIM is a speed limit value and has an unsigned 4-byte data. The unit for the speed limit is [maximum motor speed /40000000H]. (Set Pn002 to enable VLIM.) Use the ADJ command to obtain the maximum motor speed. TQREF is a torque (force) reference and has a signed 4-byte data. The unit for torque (force) reference is [maximum motor torque (force)/40000000H]. The direction is specified by the sign. When the designation for TQREF exceeds the maximum motor torque (force), it is clamped at the maximum motor torque (force). Use ADJ command to obtain the maximum motor torque (force). During execution of this command, the following bits of STATUS field are allocated. <ul style="list-style-type: none"> D11: V_LIM (speed limit bit) <ul style="list-style-type: none"> 0: Speed limit not detected 1: Speed limit detected Monitor (MONITOR 1, 2, 3, 4) <ul style="list-style-type: none"> The unit for TRQ is [maximum motor torque (force)/40000000H]. 			
4						
5	VLIM	MONITOR1				
6						
7						
8						
9	TQREF	MONITOR2				
10						
11						
12						
13	SEL_MON1/2	SEL_MON1/2				
14		IO_MON				
15						
16	WDT	RWDT				
17	Subcommand area	Subcommand area				
18						
19						
20						
21						
22						
23						
24						
25						
26						
27						
28						
29						

(2) Speed Limit Option 1

■ When Using a Rotational Servomotor

Use Pn407(Speed Limit during Torque Control) to set the speed limit.

Pn407	Speed Limit during Torque Control			
	Setting Range	Unit	Factory Setting	When Enabled
	0 to 10000	1 min ⁻¹	10000	Immediately

Note: If a speed higher than the maximum speed of the connected servomotor is set, the servomotor speed will be limited to its maximum speed.

■ When Using a Linear Servomotor

Use Pn480 (Speed Limit during Force Control) to set the speed limit.

Pn480	Speed Limit during Force Control			
	Setting Range	Unit	Factory Setting	When Enabled
	0 to 5000	mm/s	5000	Immediately

Note: If a speed higher than the maximum speed of the connected servomotor is set, the servomotor speed will be limited to its maximum speed.

(3) Speed Limit Option 2

Set the following parameter to enable VLIM (Speed Limit) specified in TRQCTRL command.

Parameter	Description
Pn002	n. <input type="checkbox"/> <input type="checkbox"/> <input type="checkbox"/> <input type="checkbox"/>
	Disables VLIM. (factory setting)
	n. <input type="checkbox"/> <input type="checkbox"/> <input type="checkbox"/> <input type="checkbox"/>
	Enables VLIM (Uses VLIM as the speed limit.)

Command Related Parameters

This chapter describes parameter settings related to each command action.

5.1	Electronic Gear Setting	5-4
5.1.1	Electronic Gear	5-4
5.1.2	Setting the Electronic Gear Ratio	5-4
5.2	Motion Acceleration/Deceleration Function Setting	5-5
5.2.1	Linear Acceleration/Deceleration Function	5-5
5.2.2	Position Reference Filter	5-6
5.2.3	Linear Deceleration Speed Setting for Commands to Stop a Motor	5-7
5.3	Motion Sequence Setting	5-9
5.3.1	Settings for EX_POSING Command	5-9
5.3.2	Settings for ZRET Command	5-9
5.4	Command Data Options	5-10
5.4.1	Torque (Force) Limiting Function	5-10
5.4.2	Torque (Force) Feed Forward Function	5-11
5.4.3	Speed Limiting Function During Torque (Force) Control	5-11
5.4.4	OPTION Field Allocation	5-12
5.5	Position Data Latch Function Setting	5-14
5.5.1	Latching Allowable Area	5-14
5.5.2	Continuous Latch Function	5-14
5.6	Acceleration/Deceleration Parameter High-speed Switching Function	5-17
5.7	STATUS Field and Monitor Related Settings	5-20
5.7.1	STATUS Field Status Detection Level Setting	5-20
5.7.2	I/O Monitor Field Signal Allocation	5-22
5.7.3	Option Monitor Setting	5-23

This chapter describes the following parameters related to command actions.

Classification	Parameter	Name	Description
Settings According to Machine	Pn20E, Pn210	Electronic Gear Ratio	Sets the unit of position data.
	Pn000	Direction Selection	Sets the servomotor rotation direction.
	Pn50A, Pn50B	Overtravel Signal Setting	Sets the overtravel function and software limit operation.
	Pn801	Software Limit Function Setting	
	Pn804, Pn806	Software Limit	
Pn808	Absolute Encoder Origin Offset	Sets the origin when using an absolute encoder.	
Motion Acceleration/Deceleration Function Settings	Pn833	Motion Setting	Sets the acceleration/deceleration speed for POSING, EX_POSING, FEED, ZRET, HOLD commands
	Pn80A, Pn834	1st Linear Acceleration Constant	
	Pn80B, Pn836	2nd Linear Acceleration Constant	
	Pn80C, Pn838	Acceleration Constant Switching Speed	
	Pn80D, Pn83A	1st Linear Deceleration Constant	
	Pn80E, Pn83C	2nd Linear Deceleration Constant	
	Pn80F, Pn83E	Deceleration Constant Switching Speed	Sets the deceleration speed for HOLD, SV_OFF commands.
	Pn827, Pn840	Linear Deceleration Constant for Stopping	
	Pn829	SVOFF Waiting Time	Sets the position reference filter.
	Pn810	Exponential Function Acceleration/Deceleration Bias	
Pn811	Exponential Function Acceleration/Deceleration Time Constant		
Pn812	Movement Average Time		
Motion Sequence Setting	Pn814	Final Travel Distance for External Positioning	Sets the travel distance after the external signal is input for positioning.
	Pn816	Homing Mode Setting	Sets the homing operation.
	Pn817, Pn818	Homing Approach Speed	
	Pn819	Final Travel Distance for Homing	
Command Data Option Setting	Pn81F, Pn002	Torque (Force) Reference Options for Speed/Position Control	Sets the usage of torque (force) limit and torque (force) feed forward during position/speed control.
	Pn002 Pn407, Pn480	Speed Limit during Torque (Force) Control	Sets the usage of speed limit during torque (force) control.
	Pn81F, Pn82A to Pn82E	OPTION Field Allocation	Selects function bits to be assigned in OPTION field.
Position Data Latch Function Setting	Pn820, Pn822	Latching Allowable Area	Sets the range to latch position data.
	Pn850	Latch Sequence Number	Sets continuous latch operation executed by LTMOD_ON command.
	Pn851	Continuous Latch Count	
	Pn852, Pn853	Latch Sequence Signal Selection	
Acceleration/Deceleration Parameter High-speed Switching Function Setting	Pn900	Parameter Bank Number	Sets the acceleration/deceleration parameter high-speed switching function.
	Pn901	Parameter Bank Member Number	
	Pn902 to Pn910	Parameter Bank Member Definition	
	Pn920 to Pn95F	Parameter Bank Data	

Classification	Parameter	Name	Description
STATUS Field and Monitor Related Settings	Pn803	Origin Range	Sets the following monitoring items. <ul style="list-style-type: none"> • STATUS field signal status detection level • Input signal allocation to the D12 to D15 bits of I/O Monitor field • Data mapping to option monitors
	Pn522	Positioning Completed Width	
	Pn524	NEAR Signal Width	
	Pn502, Pn581	Rotation Detection Level	
	Pn503, Pn582	Speed Coincidence Signal Output Width	
	Pn81E	Input Signal Monitor Selection	
	Pn824, Pn825	Option Monitor Selection	

5.1 Electronic Gear Setting

5.1.1 Electronic Gear

The electronic gear enables the servomotor travel distance per input reference pulse from the host controller to be set to any value. One reference pulse from the host controller is the minimum unit, and is called “one reference unit”.

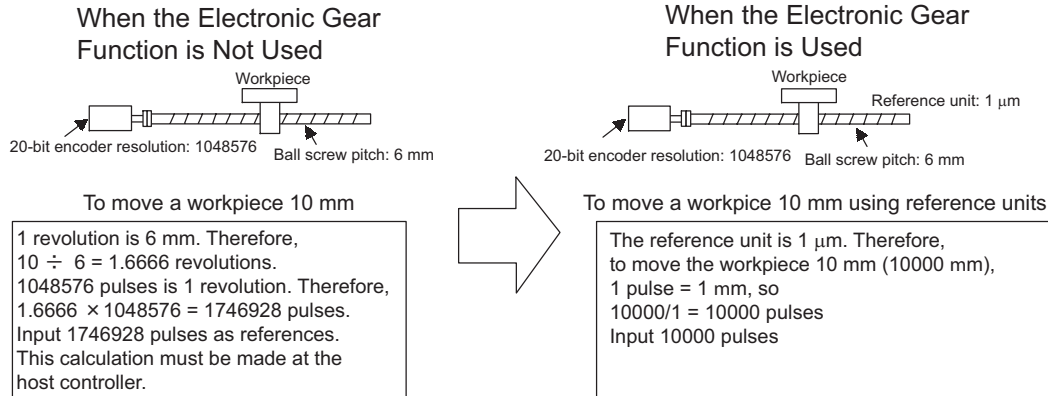

5.1.2 Setting the Electronic Gear Ratio

Use the parameters Pn20E and Pn210 to set the electronic gear ratio.

Pn20E	Electronic Gear Ratio (Numerator) Position				Classification
	Setting Range	Setting Unit	Factory Setting	When Enabled	
	1 to 1073741824 (2^{30})	–	4	After restart	
Pn210	Electronic Gear Ratio (Denominator) Position				Classification
	Setting Range	Setting Unit	Factory Setting	When Enabled	
	1 to 1073741824 (2^{30})	–	1	After restart	

If the decelerator ratio of the motor and load shaft is given as n/m, where m is the rotation of the motor and n is the rotation of the load shaft,

$$\text{Electronic gear ratio } \frac{B}{A} = \frac{Pn20E}{Pn210} = \frac{\text{Encoder resolution}}{\text{Travel distance per load shaft rotation (reference unit)}} \times \frac{m}{n}$$

5.2 Motion Acceleration/Deceleration Function Setting

This section describes the parameters used to set the acceleration/deceleration function for motion commands for positioning.

5.2.1 Linear Acceleration/Deceleration Function

Use the following parameters to set the acceleration/deceleration constants used to execute POSING, FEED, EX_POSING, ZRET, or HOLD commands.

The 1st digit of Pn833 is used to switch the parameters used for acceleration/deceleration: the parameters Pn80A to Pn80F and Pn827 or the parameters Pn834 to Pn840.

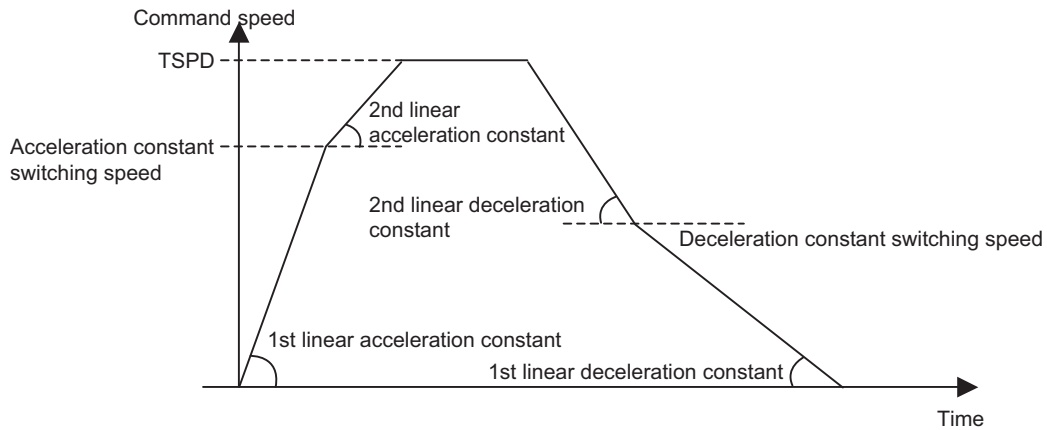

(1) Acceleration/Deceleration Constant Switching Setting

Parameter	Meaning	Factory Setting
Pn833	n.□□□0 Use parameters Pn80A to Pn80F and Pn827. (Parameters Pn834 to Pn840 are invalid.)	n.□□□0
	n.□□□1 Use parameters Pn834 to Pn840. (Parameters Pn80A to Pn80F and Pn827 are invalid.)	

Note: The setting will be validated by turning the power supply OFF and then ON again, or by executing the CONFIG command.

(2) Acceleration/Deceleration Parameters when Pn833=n.□□□0

Parameter No.	Name	Data Size (byte)	Setting Range	Unit	Factory Setting
Pn80A	1st Linear Acceleration Constant 1	2	1 to 65535	10000 reference units/s ²	100
Pn80B	2nd Linear Acceleration Constant 1	2	1 to 65535	10000 reference units/s ²	100
Pn80C	Acceleration Constant Switching Speed 1	2	0 to 65535	100 reference units/s	0
Pn80D	1st Linear Deceleration Constant 1	2	1 to 65535	10000 reference units/s ²	100
Pn80E	2nd Linear Deceleration Constant 1	2	1 to 65535	10000 reference units/s ²	100
Pn80F	Deceleration Constant Switching Speed 1	2	0 to 65535	100 reference units/s	0
Pn827	Linear Deceleration Constant 1 for Stopping	2	0 to 65535	10000 reference units/s ²	100

(3) Acceleration/Deceleration Parameters when Pn833=n.□□□1

Parameter No.	Name	Data Size (byte)	Setting Range	Unit	Factory Setting
Pn834	1st Linear Acceleration Constant 2	4	1 to 20971520	10000 reference units/s ²	100
Pn836	2nd Linear Acceleration Constant 2	4	1 to 20971520	10000 reference units/s ²	100
Pn838	Acceleration Constant Switching Speed 2	4	0 to 2097152000	Reference unit/s	0
Pn83A	1st Linear Deceleration Constant 2	4	1 to 20971520	10000 reference units/s ²	100
Pn83C	2nd Linear Deceleration Constant 2	4	1 to 20971520	10000 reference units/s ²	100
Pn83E	Deceleration Constant Switching Speed 2	4	0 to 2097152000	Reference unit/s	0
Pn840	Linear Deceleration Constant 2 for Stopping	4	0 to 20971520	10000 reference units/s ²	100

Note: If the deceleration distance exceeds 1073741823 reference units during positioning, the motor cannot be accelerated to the target speed TSPD specified in the motion command. Set the parameter for deceleration speed to a value that satisfies the following equation.

$$\text{Deceleration speed [reference unit/s}^2] \geq \text{Max. command speed}^2 \text{ [reference unit/s]} / (\text{Max. deceleration distance [reference unit]} \times 2)$$

5.2.2 Position Reference Filter

A filter can be applied to the position reference output of a positioning command such as INTERPOLATE, LATCH, POSING, FEED, EX_POSINT, ZRET, and HOLD.

(1) Position Reference Filter Setting Parameters

Parameter No.	Name	Data Size (byte)	Setting Range	Unit	Factory Setting
Pn810	Exponential Function Acceleration/Deceleration Bias	2	0 to 65535	100 reference units/s	0
Pn811	Exponential Function Acceleration/Deceleration Time Constant	2	0 to 5100	0.1 ms	0
Pn812	Movement Average Time	2	0 to 5100	0.1 ms	0

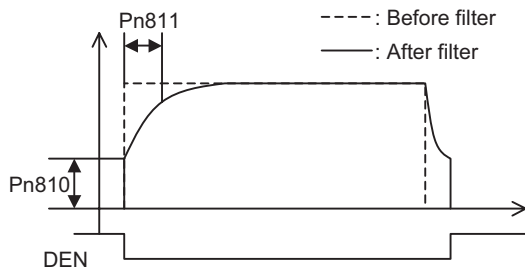

Exponential Function Acceleration/Deceleration Curve

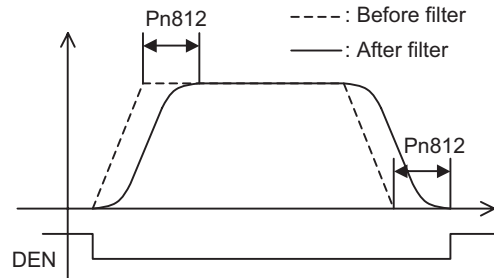

Movement Average Time Curve

(2) Position Reference Filter Type Selection

Use the ACCFIL bit of the OPTION field to specify the position reference filter type.

ACCFIL	Meaning
0	Without position reference filter
1	Exponential function acceleration/deceleration position reference filter
2	Movement average time position reference filter

Information: While a position reference is being output (STATUS.DEN = 0), the parameter or the filter type cannot be changed. Wait for completion of the position reference output (STATUS.DEN = 1) to change the setting.

5.2.3 Linear Deceleration Speed Setting for Commands to Stop a Motor

Set the deceleration speed when using either of the following commands to stop a motor.

- HOLD (When HOLD_MOD = 2)
- SV_OFF (When Pn829 ≠ 0)

(1) Setting for Deceleration to a Stop by Executing HOLD Command (HOLD_MOD = 2)

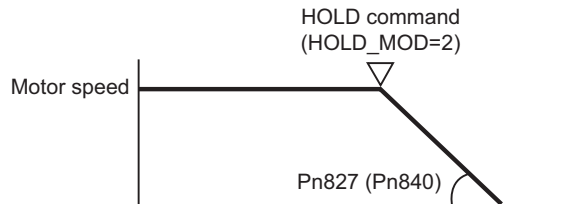

The parameter number in parentheses is when Pn833 = 1.

Parameter No.	Name	Data Size (byte)	Setting Range	Unit	Factory Setting
Pn827	Linear Deceleration Constant 1 for Stopping	2	0 to 65535	10000 reference units/s ²	100
Pn840	Linear Deceleration Constant 2 for Stopping	4	0 to 20971520	10000 reference units/s ²	100

(2) Setting for Deceleration to a Stop by Executing SV_OFF Command

When SV_OFF command is executed while a motor is running, the servo can be turned OFF after deceleration to a stop.

When Pn829 is set to 0 (factory setting), the servo will turn OFF immediately upon reception of the SV_OFF command.

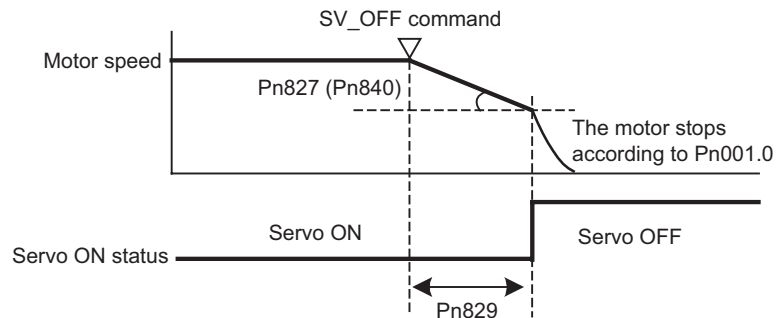

The parameter number in parentheses is when Pn833 = 1.

5.2.3 Linear Deceleration Speed Setting for Commands to Stop a Motor

Parameter No.	Name	Data Size (byte)	Setting Range	Unit	Factory Setting
Pn827	Linear Deceleration Constant 1 for Stopping	2	0 to 65535	10000 reference units/s ²	100
Pn829	SVOFF Waiting Time (SVOFF at deceleration to stop)	2	0 to 65535	10 ms	0
Pn840	Linear Deceleration Constant 2 for Stopping	4	0 to 20971520	10000 reference units/s ²	100

5.3 Motion Sequence Setting

This section describes parameters related to the actions of EX_POSING and ZRET commands.

5.3.1 Settings for EX_POSING Command

Set the travel distance from the external signal input position to the final target position for execution of an EX_POSING command. If a negative value (distance to the negative direction) or a small value is set, the axis will decelerate to a stop and then move to the reverse direction for positioning.

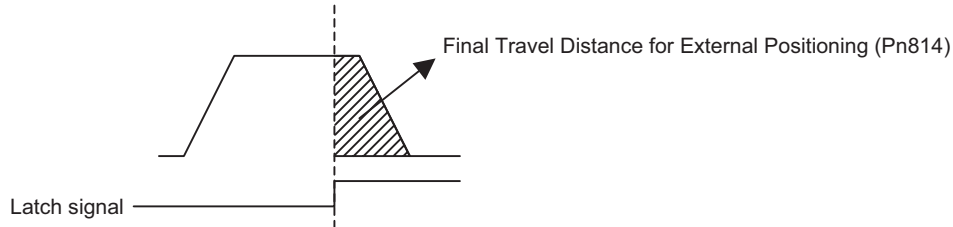

Parameter No.	Name	Data Size (byte)	Setting Range	Unit	Factory Setting
Pn814	Final Travel Distance for External Positioning	4	-1073741823 to 1073741823	Reference unit	100

5.3.2 Settings for ZRET Command

This section describes the parameters to set the following items for ZRET command.

- Pn816: Homing direction selection
- Pn817: Approach speed after the origin limit signal is input (DEC signal turns ON)
- Pn818: Approach (creep) speed after the latch signal is input
- Pn819: Final travel distance from the latch signal input position to the origin

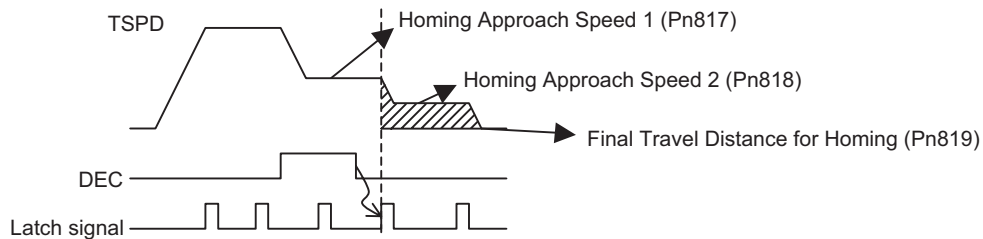

Parameter	Meaning	Factory Setting
Pn816	n.□□□0	n.□□□0
	n.□□□1	

Parameter No.	Name	Data Size (byte)	Setting Range	Unit	Factory Setting
Pn817	Homing Approach Speed 1	2	0 to 65535	100 reference units/s	50
Pn818	Homing Approach Speed 2	2	0 to 65535	100 reference units/s	5
Pn819	Final Travel Distance for Homing	4	-1073741823 to 1073741823	Reference unit	100

Information: Set Pn819 (Final Travel Distance for Homing) to a value that satisfies the following equation.

When Pn816=n.□□□0: Origin = Latch signal input position + Pn819

When Pn816=n.□□□1: Origin = Latch signal input position - Pn819

5.4 Command Data Options

5.4.1 Torque (Force) Limiting Function

The torque (force) limiting function limits the output torque (force) to protect the connected machine, etc. There are three ways to limit the output torque (force).

1. Internal torque (force) limit
2. External torque (force) limit using P_CL/N_CL signal of OPTION field
3. Torque (force) limit by position/speed control command

Information: If all of the above three methods are used, the smallest torque (force) limit will be applied.

(1) Internal Torque (Force) Limit

This method always limits the maximum output torque (force) to the set values of the following parameters.

Parameter No.	Name	Data Size (byte)	Setting Range	Unit	Factory Setting
Pn402	Forward Torque Limit (For rotational servomotors)	2	0 to 800	%	800
Pn403	Reverse Torque Limit (For rotational servomotors)	2	0 to 800	%	800
Pn483	Forward Force Limit (For linear servomotors)	2	0 to 800	%	30
Pn484	Reverse Force Limit (For linear servomotors)	2	0 to 800	%	30

Information: Set the limit value in percentage (%) of the motor rated torque (force).

(2) External Torque (Force) Limit Using P_CL/N_CL Signal of OPTION Field

This method uses the P_CL/N_CL signal of the OPTION field to limit the output torque (force) to the set values of the following parameters.

Parameter No.	Name	Data Size (byte)	Setting Range	Unit	Factory Setting
Pn404	Forward External Torque (Force) Limit	2	0 to 800	%	100
Pn405	Reverse External Torque (Force) Limit	2	0 to 800	%	100

Information: Set the limit value in percentage (%) of the motor rated torque (force).

(3) Torque (Force) Limit By Position/Speed Control Command

This methods limits the output torque (force) by setting a desired limit value in the command data (TLIM/P_TLIM/N_TLIM).

[Torque (Force) Limiting Function Settable Commands]

INTERPOLATE, LATCH, FEED, EX_POSING, ZRET, and VELCTRL

[Setting Parameters]

Set the following parameters to apply a torque (force) limit from a position/speed control command.

Pn81F	Position Control Command TFF/TLIM Function Allocation	
	n.□□1□	Enables allocation (Set TFF/TLIM operation using Pn002.)
Pn002	Torque (force) Reference Option During Speed/Position Control	
	n.□□□1	Enables positive/negative torque (force) limit by *TLIM.
	n.□□□3	Uses TLIM/P_TLIM as positive torque (force) limit when OPTION.P_CL=1. Uses TLIM/N_TLIM as negative torque (force) limit when OPTION.N_CL=1.

Information 1. When using a torque (force) limit set in a position control command, set Pn81F and Pn002 as follows:

Pn81F = n.□□1□, and Pn002 = n.□□□1 or n.□□□3

If Pn81F = n.□□0□, the torque (force) limit set in the position control command will not be applied.

2. When using a torque (force) limit set in a speed control command, set Pn002 as follows.
Pn002 = n.□□□1 or n.□□□3

3. When a command other than the commands listed in [Torque (Force) Limiting Function Settable Commands], the torque (force) limit of the previously executed TLIM/P_TLIM/N_TLIM remains valid. During execution of HOLD, SV_OFF, SVCTRL, or TRQCTRL command, the torque (force) limit specified by TLIM/P_TLIM/N_TLIM is invalid.

5.4.2 Torque (Force) Feed Forward Function

This function is used to apply a torque (force) feed forward (TFF) from a position/speed control command.

[Torque (Force) Feed Forward Reference Settable Commands]

INTERPOLATE, LATCH, and VELCTRL

[Setting Parameters]

Set the following parameters to use TFF as the torque (force) feed forward.

Pn81F	Position Control Command TFF/TLIM Function Allocation	
	n.□□1□	Enables allocation (Set TFF/TLIM operation using Pn002.)
Pn002	Torque (force) Reference Option During Speed/Position Control	
	n.□□□2	Enables the torque (force) feed forward by TFF.

Information 1. To use the torque (force) feed forward in a position control command, set the parameters as follows.

Pn81F = n.□□1□ and Pn002 = n.□□□2

If Pn81F = n.□□0□, the torque (force) feed forward by a position control command is disabled.

2. To use the torque (force) feed forward in a speed control command, set the parameter as follows.
Pn002 = n.□□□2

5.4.3 Speed Limiting Function During Torque (Force) Control

This function limits the servomotor speed during torque (force) control to protect the connected machine, etc.

There are two ways to control the speed during torque control:

1. Internal speed limit
2. Speed limit by the torque (force) control command TRQCTRL

Information: If both of the above methods are used, the smaller speed limit will be applied.

(1) Internal Speed Limit

This method always limits the servomotor speed to either of the following set parameter values.

Parameter No.	Name	Data Size (byte)	Setting Range	Unit	Factory Setting
Pn407	Speed Limit during Toque Control (For rotational servomotors)	2	0 to 10000	min ⁻¹	10000
Pn480	Speed Limit during Force Control (For linear servomotors)	2	0 to 10000	mm/s	10000

(2) Speed Limit by Torque (Force) Control Command TRQCTRL

This method limits the speed by setting a desired speed limit value in the command data (VLIM).

[Setting Parameter]

Set the following parameter to use the speed limit set in TRQCTRL command.

Torque (Force) Reference Option		
Pn002	n.□□0□	Disables the speed limit set in the VLIM. (Factory setting)
	n.□□1□	Enables the speed limit set in the VLIM.

5.4.4 OPTION Field Allocation

The commands can be allocated to the OPTION field using the following parameters. To change the factory setting, set Pn81F = □□□1 and allocate the function bits using parameters Pn82A to Pn82E. The setting will be validated by turning the power supply OFF and then ON again, or by executing CONFIG.

[Setting Parameters]

Parameter		Name		Setting Range	Factory Setting	
No.	Digit					
Pn81F	Command Data Allocation				0000h to 011h	0000h
	0	OPTION Field Allocation		0 or 1	0	
		0	Disables OPTION field allocation.			
	1	Enables OPTION field allocation.				
Pn82A	OPTION Field Allocation 1				0000H to 1E1EH	1813H
	0	0 to E	ACCFIL bit position			3
		0	Disables ACCFIL bit allocation.			1
	1	1	Enables ACCFIL bit allocation.			
		0 to E	GSEL bit position			8
	3	0	Disables GSEL bit allocation.			1
1		Enables GSEL bit allocation.				
Pn82B	OPTION Field Allocation 2				0000H to 1F1FH	1D1CH
	0	0 to F	V_PPI bit position			C
		0	Disables V_PPI bit allocation			1
	1	1	Enables V_PPI bit allocation.			
		0 to F	P_PI_CLR bit position			D
	3	0	Disables P_PI_CLR bit allocation.			1
1		Enables P_PI_CLR bit allocation.				

Parameter		Name		Setting Range	Factory Setting
No.	Digit				
Pn82C		OPTION Field Allocation 3		0000H to 1F1FH	1F1EH
	0	0 to F	P_CL bit position		E
	1	0	Disables P_CL bit allocation.		1
		1	Enables P_CL bit allocation.		
	2	0 to F	N_CL bit position		F
	3	0	Disables N_CL bit allocation.		1
		1	Enables N_CL bit allocation.		
Pn82D		OPTION Field Allocation 4		0000H to 1F1CH	0000H
	0	0 to C	BANK_SEL1 bit position		0
	1	0	Disables BANK_SEL1 bit allocation.		0
		1	Enables BANK_SEL1 bit allocation.		
	2	0 to F	LT_DISABLE bit position		0
	3	0	Disables LT_DISABLE bit allocation.		0
		1	Enables LT_DISABLE bit allocation.		
Pn82E		OPTION Field Allocation 5		0000H to 1D1FH	0000H
	0	0 to F	Reserved		0
	1	0	Reserved		0
		1	Reserved		
	2	0 to D	OUT_SIGNAL bit position		0
	3	0	Disables OUT_SIGNAL bit allocation.		0
		1	Enables OUT_SIGNAL bit allocation.		

Note: 1. Do not allocate more than one signal to one bit. If more than one signal is allocated to one bit, the bit will control more than one signal.

2. An unallocated function bit acts as if it is set to 0.

3. Set the bit to the least significant bit position to be allocated.

5.5 Position Data Latch Function Setting

This section describes the parameters for setting the position data latch function.

5.5.1 Latching Allowable Area

Use the following parameters to set the range to input the latch signal for position data latching by LTMOD_ON, LATCH, EX_POSING, or ZRET command. If the latch signal is input out of the set range, position data will not be latched.

Parameter No.	Name	Data Size (byte)	Setting Range	Unit	Factory Setting
Pn820	Forward Latching Allowable Area	4	-2147483648 to 2147483647	Reference unit	0
Pn822	Reverse Latching Allowable Area	4	-2147483648 to 2147483647	Reference unit	0

(1) When Pn820 > Pn822

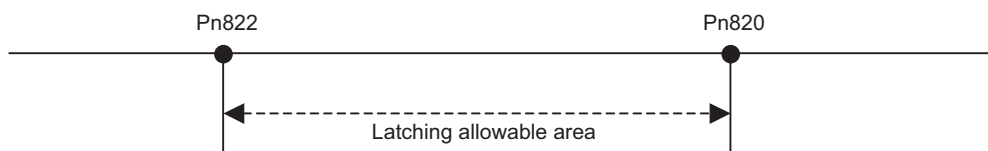

(2) When Pn820 ≤ Pn822

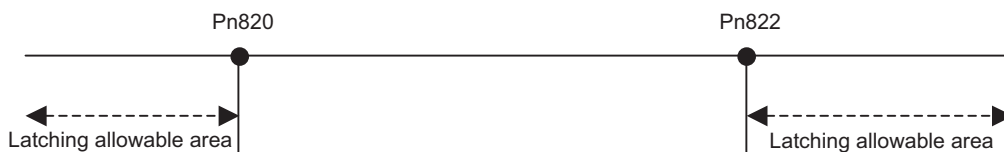

5.5.2 Continuous Latch Function

This function sequentially latches the input positions of sequence signal 1 to sequence signal n (n = 1 to 8) for a specified number of times. The continuous latch operation can be aborted by executing the LTMOD_OFF command. This function can shorten the time between latch completion and the start of the next latch, and enables sequential latch operations at high speed.

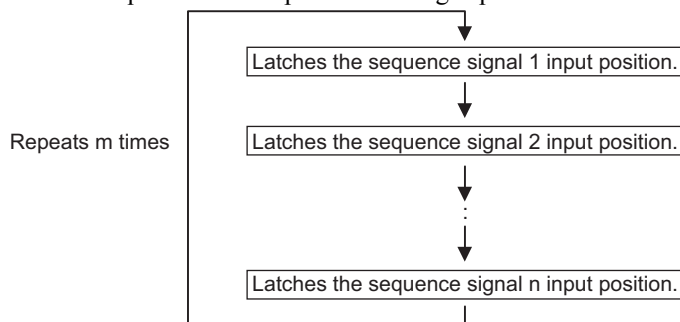

- Note 1: N, the number of sequence signals, is specified by Pn850.
 2: The signals for sequence signal n are selected by Pn852 and Pn853.
 3: The number of times of continuous latching m is set by Pn851.

[How to Start and Stop Continuous Latch Operation]

Set the following parameters, and then set LT_MOD to 1 to execute the LTMOD_ON command. The continuous latch operation will start. To abort the operation, execute the LTMOD_OFF command.

Pn850: Latch Sequence Number n

Pn851: Continuous Latch Count m (When m = 0, the continuous latch operation will be infinitely repeated.)

Pn852: Latch Sequence Signal 1 to 4 Setting

Pn853: Larch Sequence Signal 5 to 8 Setting

Note: If the LTMOD_ON command is executed by setting Pn850 to 0 and LT_MOD to 1, the latch mode error warning (A.94E) will occur and the latch operation will not start.

[Latch Status]

Latch completion can be confirmed by the following status.

[STATUS Field: The 3rd and 4th byte]

L_CMP (D10): L_CMP is set to 1 for one communications cycle every time the external signal is input.

[EX_STATUS Field: The 28th and 29th byte]

L_SEQ_NO (D8-D11): The latch sequence signal number (value n) at latch completion

L_CMP_CNT (D0-D7): The continuous latch count (value m)
(Added at completion of position latch when the latch sequence signal n is input.)

Note: LPOS is forcibly output to MONITOR 2 for one communications cycle while L_CMP = 1 every time the external signal is input.

[Operation Example]

An example of a continuous latch operation using two latch sequence signals EXT1 and EXT2 is illustrated below. (The parameters are set as follows: Pn850 = 2, Pn851 = 2 or more, Pn852 = 0021H, Pn853 = any)

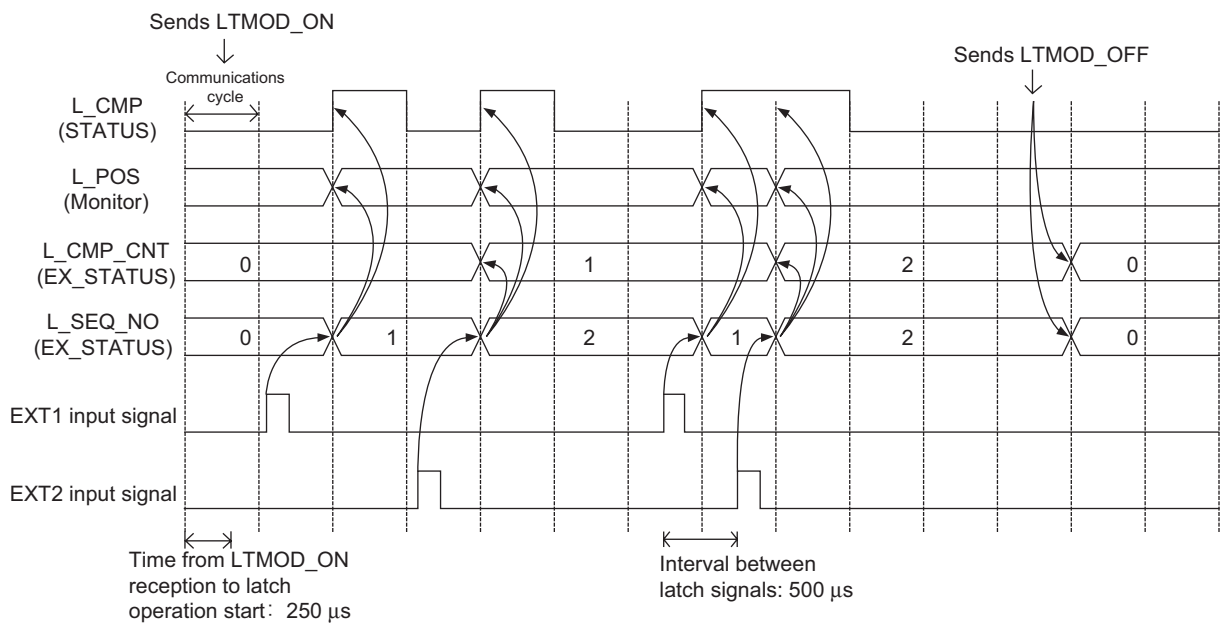

[Setting Parameters]

Parameter		Name		Data Size (byte)	Setting Range	Unit	Factory Setting	
No.	Digit							
Pn850		Latch Sequence Number		2	0 to 8	–	0	
Pn851		Continuous Latch Count		2	0 to 255	–	0	
Pn852		Latch Sequence Signal 1 to 4 Setting		2	0000H to 3333H	–	0000H	
	0	Latch sequence 1 signal selection	0	Phase C	/	0 to 3	–	0
			1	EXT1 signal				
			2	EXT2 signal				
			3	EXT3 signal				
	1	Latch sequence 2 signal selection	0	Phase C	/	0 to 3	–	0
			1	EXT1 signal				
			2	EXT2 signal				
			3	EXT3 signal				
	2	Latch sequence 3 signal selection	0	Phase C	/	0 to 3	–	0
			1	EXT1 signal				
			2	EXT2 signal				
			3	EXT3 signal				
	3	Latch sequence 4 signal selection	0	Phase C	/	0 to 3	–	0
			1	EXT1 signal				
			2	EXT2 signal				
			3	EXT3 signal				
Pn853		Latch Sequence Signal 5 to 8 Setting		2	0000H to 3333H	–	0000H	
	0	Latch sequence 5 signal selection	0	Phase C	/	0 to 3	–	0
			1	EXT1 signal				
			2	EXT2 signal				
			3	EXT3 signal				
	1	Latch sequence 6 signal selection	0	Phase C	/	0 to 3	–	0
			1	EXT1 signal				
			2	EXT2 signal				
			3	EXT3 signal				
	2	Latch sequence 7 signal selection	0	Phase C	/	0 to 3	–	0
			1	EXT1 signal				
			2	EXT2 signal				
			3	EXT3 signal				
	3	Latch sequence 8 signal selection	0	Phase C	/	0 to 3	–	0
			1	EXT1 signal				
			2	EXT2 signal				
			3	EXT3 signal				

[Application Notes]

1. The minimum interval between latch signals is 500 μ s. An interval between latch signals that is longer than the communications cycle is required to continuously obtain latched position data.
2. If two latch signals are input without allowing the minimum required interval, only the first latch signal input position will be latched. The second latch signal will be ignored.
3. Use a subcommand to monitor completion status of continuous latch count.etc.
4. The parameters Pn850 to Pn853 can be changed only while the continuous latch operation is stopped.

5.6 Acceleration/Deceleration Parameter High-speed Switching Function

This function switches, at high-speed, the acceleration/deceleration parameters that are used for positioning executed by the POSING, FEED, EX_POSING, ZRET, or HOLD commands.

Register the acceleration/deceleration parameter settings in a bank before starting operation, and execute the bank selector BANK_SEL to switch the acceleration/deceleration parameter settings to those of the registered bank.

[Bank Selector Allocation]

Allocate the following bank selector BANK_SEL1 in the OPTION field. (The allocation is disabled by default. Refer to (5) *OPTION Field Specifications of chapter 7 Data Field* for details on bit allocation methods.)

Name	Description	Setting Data
BANK_SEL1	Bank selector	Bank 0 to 15

[Parameter Bank Setting]

Set the following parameters.

Parameter No.	Name	Data Size (byte)	Setting Range	Factory Setting
Pn900	Parameter Bank Number	2	0 to 16	0
Pn901	Parameter Bank Member Number	2	0 to 15	0
Pn902 to Pn910	Parameter Bank Member Definition	2	0000H to 08FFH	0
Pn920 to Pn95F *	Parameter Bank Data	2	0000H to FFFFH Depends on bank member.	0

* The parameters Pn920 to Pn95F will not be stored in the non-volatile memory. They need to be set every time the power is turned ON.

[Parameters that Can be Registered as Bank Members]

The following parameters can be registered as parameter bank members among parameters Pn902 to Pn910. For 4-byte parameters, one parameter must be registered as two consecutive members. (See Setting Example 2.)

Parameter No.	Name	Data Size (byte)	Setting Range	Unit	Factory Setting
Pn80A	1st Linear Acceleration Constant 1	2	1 to 65535	10000 reference units/s ²	100
Pn80B	2nd Linear Acceleration Constant 1	2	1 to 65535	10000 reference units/s ²	100
Pn80C	Acceleration Constant Switching Speed 1	2	0 to 65535	100 reference units/s	0
Pn80D	1st Linear Deceleration Constant 1	2	1 to 65535	10000 reference units/s ²	100
Pn80E	2nd Linear Deceleration Constant 1	2	1 to 65535	10000 reference units/s ²	100
Pn80F	Deceleration Constant Switching Speed 1	2	0 to 65535	100 reference units/s	0
Pn834	1st Linear Acceleration Constant 2	4	1 to 20971520	10000 reference units/s ²	100
Pn836	2nd Linear Acceleration Constant 2	4	1 to 20971520	10000 reference units/s ²	100
Pn838	Acceleration Constant Switching Speed 2	4	0 to 2097152000	Reference unit/s	0

Parameter No.	Name	Data Size (byte)	Setting Range	Unit	Factory Setting
Pn83A	1st Linear Deceleration Constant 2	4	1 to 20971520	10000 reference units/s ²	100
Pn83C	2nd Linear Deceleration Constant 2	4	1 to 20971520	10000 reference units/s ²	100
Pn83E	Deceleration Constant Switching Speed 2	4	0 to 2097152000	Reference unit/s	0
Pn810	Exponential Function Acceleration/Deceleration Bias	2	0 to 65535	100 reference units/s	0
Pn811	Exponential Function Acceleration/Deceleration Time Constant	2	0 to 5100	0.1 ms	0
Pn812	Movement Average Time	2	0 to 5100	0.1 ms	0

[Setting Procedure]

STEP 1:

1. Set Pn900 (Parameter Bank Number) to m.
2. Set Pn901 (Parameter Bank Member Number) to n.
Set Pn900 and Pn901 so that $Pn900 \times Pn901 \leq 64$.
3. Register bank member parameter numbers using parameters Pn902 to Pn910.
4. To enable the bank function, execute the CONFIG command or turn the power supply OFF and then ON again.

STEP 2:

5. Set the data of each bank in the parameter bank data area from the leading parameter Pn920 in order as shown below.
Bank 0: Pn920 to Pn (920+n-1)
Bank 1: Pn (920+n) to Pn (920+2n-1)
...
Bank m-1: Pn {920+(m-1) \times n} to Pn (920+m \times n-1)

- Note: 1. If parameters Pn900 to Pn910 set in STEP 1.1, 1.2, and 1.3 are saved in the non-volatile memory, carry out STEP 2.5 only after power up.
However, if you turn the power supply OFF and then ON again after saving parameters Pn900 to Pn910 in the non-volatile memory, and start the operation without setting parameters Pn920 to Pn95F, the operation will be carried out under the condition that all bank data is set to 0 (zero) or the minimum setting.
2. If parameters Pn900 to Pn910 set in STEP 1.1, 1.2, and 1.3 are not saved in the non-volatile memory, carry out STEP 1.1 to 2.5 each time the power supply is turned ON.

Setting Example 1: Switching three banks of members Pn80B, Pn80E, and Pn80C

Pn900 = 3	Bank number	Pn920 = 80BH value	Bank 0
Pn901 = 3	Bank number	Pn921 = 80EH value	
		Pn922 = 80CH value	
Pn902 = 80BH	Member 1	Pn923 = 80BH value	Bank 1
Pn903 = 80EH	Member 2	Pn924 = 80EH value	
Pn904 = 80CH	Member 3	Pn925 = 80CH value	
		Pn926 = 80BH value	Bank 2
		Pn927 = 80EH value	
		Pn928 = 80CH value	

Setting Example 2: Switching two banks of members Pn836, Pn83C, and Pn838

Pn900 = 2	Bank number	Pn920 = 836H LS word	Bank 0
Pn901 = 6	Bank number	Pn921 = 836H MS word	
		Pn922 = 83CH LS word	
Pn902 = 836H	Member 1	Pn923 = 83CH MS word	Bank 1
Pn903 = 836H	Member 2	Pn924 = 838H LS word	
Pn904 = 83CH	Member 3	Pn925 = 838H MS word	
Pn905 = 83CH	Member 4	Pn926 = 836H LS word	
Pn906 = 838H	Member 5	Pn927 = 836H MS word	
Pn907 = 838H	Member 6	Pn928 = 83CH LS word	
		Pn929 = 83CH MS word	
		Pn92A = 838H LS word	
		Pn92B = 838H MS word	

[Application Notes]

- If Pn900 (Parameter Bank Number) or Pn901 (Parameter Bank Member Number) is set to 0, the bank function will be disabled.
- If one parameter is registered for more than one bank member definition, the bank data of the biggest bank member definition parameter number will be applied.
- If the bank selector BANK_SEL is not allocated to the function bit of the OPTION field, the data of Bank 0 will be always applied.
- The acceleration/deceleration parameter high-speed switching function is enabled only while DEN = 1 (Distribution Completed). The parameters will not switch while DEN = 0 (Distributing).
- In the following cases, error A.04A (parameter setting error 2) will occur when the power supply is turned ON or CONFIG command is executed.
 - One 4-byte parameter is not registered for two bank members.
 - The total number of bank data entries exceeds 64 ($Pn900 \times Pn901 > 64$).
- If a parameter that is not allowed to be a bank member is registered, the bank data of the parameter-registered member will become invalid.
- Bank data that exceeds the setting range of the registered bank member parameter will be clamped to a value within the setting range.
- If a bank number larger than the bank number set in Pn900 is specified ($BANK_SEL1 \geq Pn900$), the parameter bank will not switch and the currently active bank will be used.
- Parameters Pn920 to Pn95F will not be saved in the non-volatile memory. Therefore, they must be set each time the power supply is turned ON.

5.7 STATUS Field and Monitor Related Settings

5.7.1 STATUS Field Status Detection Level Setting

This section describes the parameters for setting the status detection levels for the STATUS field data.

(1) Origin (ZPOINT) Range Setting

Set the ZPOINT signal status detection range.

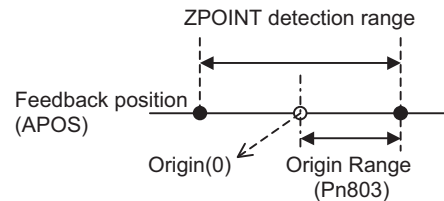

Parameter No.	Name	Data Size (byte)	Setting Range	Unit	Factory Setting
Pn803	Origin Range	2	0 to 250	Reference unit	10

Information: ZPOINT detection will be performed only after completion of the following operations. Otherwise, it will not be performed.

■ When an incremental encoder is connected

- Homing operation by ZRET command is completed.
- The coordinate setting is completed after reference point setting (REFE = 1) by executing POS_SET command.

■ When an absolute encoder is connected

- Execution of SENS_ON command is completed.

(2) Positioning Completed (PSET) Width Setting

Set the PSET signal status detection range.

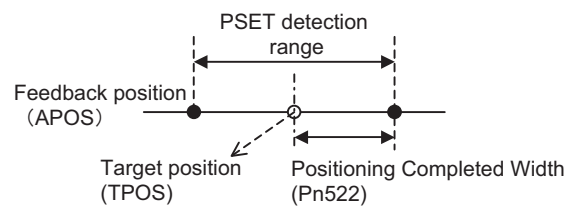

Parameter No.	Name	Data Size (byte)	Setting Range	Unit	Factory Setting
Pn522	Positioning Completed Width	4	0 to 1073741824	Reference unit	7

Information: PSET = 1 when output is completed (DEN = 1) and the feedback position (APOS) is within the positioning completed (PSET) detection range.

(3) NEAR Signal Width Setting

Set the NEAR signal status detection range.

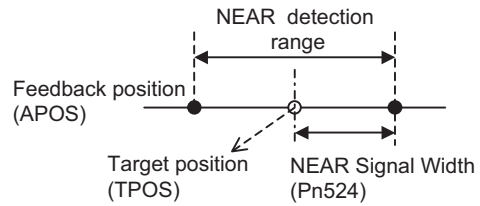

Parameter No.	Name	Data Size (byte)	Setting Range	Unit	Factory Setting
Pn524	NEAR Signal Width	4	0 to 1073741824	Reference unit	7

Information: NEAR = 1 when the feedback position (APOS) is within the NEAR signal detection range.

(4) Zero-speed (ZSPD) Detection Level Setting

Set the ZSPD signal status detection level during speed control (VELCTRL command).

Parameter No.	Name	Data Size (byte)	Setting Range	Unit	Factory Setting
Pn502	Rotation Detection Level (For rotational servomotors)	2	1 to 10000	min ⁻¹	20
Pn581	Travel Detection Level (For linear servomotors)	2	1 to 5000	mm/s	20

(5) Speed Coincidence (VCMP) Detection Level Setting

Set the VCMP signal status detection level during speed control (VELCTRL command).

Parameter No.	Name	Data Size (byte)	Setting Range	Unit	Factory Setting
Pn503	Speed Coincidence Signal Output Width (For rotational servomotors)	2	0 to 100	min ⁻¹	10
Pn582	Speed Coincidence Signal Output Width (For linear servomotors)	2	0 to 100	mm/s	10

5.7.2 I/O Monitor Field Signal Allocation

Allocate CN1 connector input signals SI0 to SI6 to bits D12 to D15 of the I/O monitor field.

Parameter		Function	Setting	Allocation	Factory Setting
No.	Digit				
Pn81E	0	IO12 Signal Mapping	0	No mapping	0
			1	Monitors SI0 signal (CN1)	
			2	Monitors SI1 signal (CN1)	
			3	Monitors SI2 signal (CN1)	
			4	Monitors SI3 signal (CN1)	
			5	Monitors SI4 signal (CN1)	
			6	Monitors SI5 signal (CN1)	
	7	Monitors SI6 signal (CN1)			
	1	IO13 Signal Mapping	1 to 7	Refer to IO12 signal mapping	0
	2	IO14 Signal Mapping	1 to 7	Refer to IO12 signal mapping	0
3	IO15 Signal Mapping	1 to 7	Refer to IO12 signal mapping	0	

5.7.3 Option Monitor Setting

Set the contents to be monitored when Option Monitor 1 and Option Monitor 2 are selected for MONITOR 1/2/3/4.

Parameter No.	Name	Remarks
	Option Monitor 1 Selection	–
	0000H Motor rotation speed [1000000H/OS]	
	0001H Speed reference [1000000H/OS]	
	0002H Torque (Force) [1000000H/max. torque (force)]	
	0003H Position error (lowermost 32 bits) [reference unit]	
	0004H Position error (uppermost 32 bits) [reference unit]	
	0005H System reserved	
	0006H System reserved	
	000AH Encoder count (lowermost 32 bits) [reference unit]	
	000BH Encoder count (uppermost 32 bits) [reference unit]	
	000CH External encoder count (lowermost 32 bits) [reference unit]	For fully-closed loop control
	000DH External encoder count (uppermost 32 bits) [reference unit]	For fully-closed loop control
	0010H Un000: Motor rotation speed [min^{-1}]	
	0011H Un001: Speed reference [min^{-1}]	
	0012H Un002: Torque (Force) reference [%]	
Pn824	0013H Un003: Rotation angle 1 [pulse]	
	0014H Un004: Rotation angle 2 [degree]	
	0017H Un005: Input position reference speed [min^{-1}]	
	0018H Un006: Input signal monitor	
	0019H Un007: Output signal monitor	
	0018H Un008: Position error [reference unit]	
	0019H Un009: Accumulated load ratio [%]	
	001AH Un00A: Regenerative load ratio [%]	
	001BH Un00B: DB resistance consumption power [%]	
	001CH Un00C: Input reference pulse [reference unit]	
	001DH Un00D: Feedback pulse [pulse]	
	001EH Un00E: Fully-closed loop feedback pulse [pulse]	For fully-closed loop control
	0023H Initial multiturn data [rev]	For rotational servomotors
	0024H Initial incremental pulse	For rotational servomotors
	0025H Initial absolute position data lowermost 32 bits [pulse]	For linear servomotors
	0026H Initial absolute position data uppermost 32 bits [pulse]	For linear servomotors
	0080H Previous value of latched feedback position (LPOS)	
Pn825	Option Monitor 2 Selection (Same as for Pn824)	–

MECHATROLINK-II Subcommands

This chapter describes MECHATROLINK-II subcommands.

6.1 No Operation (NOP: 00H)	6-2
6.2 Read Parameter (PRM_RD: 01H)	6-2
6.3 Write Parameter (PRM_WR: 02H)	6-3
6.4 Read Alarm or Warning (ALM_RD: 05H)	6-3
6.5 Write Non-volatile Parameter (PPRM_WR: 1CH)	6-4
6.6 Set Latch Mode (LTMOD_ON: 28H)	6-4
6.7 Release Latch Mode (LTMOD_OFF: 29H)	6-5
6.8 Status Monitoring (SMON: 30H)	6-5

The MECHATROLINK-II subcommands can be used by specifying them with the CONNECT command when MECHATROLINK-II communications starts.

The specifications of each MECHATROLINK-II subcommand are described below.

Refer to 1.2.3 *Combination of MECHATROLINK-II Main Commands and Subcommands* for information on applicable combinations with main commands.

6.1 No Operation (NOP: 00H)

Byte	NOP		Description
	Command	Response	
17	00H	00H	<ul style="list-style-type: none"> Not operation command
18		SUBSTATUS	
19			
20			
21			
22			
23			
24			
25			
26			
27			
28			
29			

6.2 Read Parameter (PRM_RD: 01H)

Byte	PRM_RD		Description
	Command	Response	
17	01H	01H	<ul style="list-style-type: none"> Reads the parameters. This command has the same function as the main command PRM_RD.
18		SUBSTATUS	
19	NO	NO	
20			
21	SIZE	SIZE	
22		PARAMETER	
23			
24			
25			
26			
27			
28			
29			

6.3 Write Parameter (PRM_WR: 02H)

Byte	PRM_WR		Description
	Command	Response	
17	02H	02H	<ul style="list-style-type: none"> Writes the parameters. This command has the same function as the main command PRM_WR.
18		SUBSTATUS	
19	NO	NO	
20			
21	SIZE	SIZE	
22	PARAMETER	PARAMETER	
23			
24			
25			
26			
27			
28			
29			

6.4 Read Alarm or Warning (ALM_RD: 05H)

Byte	ALM_RD		Description
	Command	Response	
17	05H	05H	<ul style="list-style-type: none"> Reads the alarm or warning. This command has the same function as the main command ALM_RD.
18		SUBSTATUS	
19	ALM_RD_MOD	ALM_RD_MOD	
20		ALM_DATA	
21			
22			
23			
24			
25			
26			
27			
28			
29			

6.5 Write Non-volatile Parameter (PPRM_WR: 1CH)

Byte	PPRM_WR		Description
	Command	Response	
17	1CH	1CH	<ul style="list-style-type: none"> Writes the parameters. This command has the same function as the main command PPRM_WR.
18		SUBSTATUS	
19	NO	NO	
20			
21	SIZE	SIZE	
22	PARAMETER	PARAMETER	
23			
24			
25			
26			
27			
28			
29			

6.6 Set Latch Mode (LTMOD_ON: 28H)

Byte	PPRM_WR		Description
	Command	Response	
17	28H	28H	<ul style="list-style-type: none"> Enables the latch mode. This command has the same function as the main command LTMOD_ON.
18	LT_SGN	SUBSTATUS	
19	SEL_MON3/4	SEL_MON3/4	
20		MONITOR3	
21			
22			
23			
24		MONITOR4	
25			
26			
27			
28		EX_STATUS	
29			

6.7 Release Latch Mode (LTMOD_OFF: 29H)

Byte	LTMOD_OFF		Description
	Command	Response	
17	29H	29H	<ul style="list-style-type: none"> Releases the latch mode. This command has the same function as the main command LTMOD_OFF.
18		SUBSTATUS	
19	SEL_MON3/4	SEL_MON3/4	
20		MONITOR3	
21			
22			
23			
24			
25			
26	MONITOR4		
27			
28			
29		EX_STATUS	

6.8 Status Monitoring (SMON: 30H)

Byte	SMON		Description
	Command	Response	
17	30H	30H	<ul style="list-style-type: none"> Reads the monitoring information specified in SEL_MON3/4. This command has the same function as the main command SMON.
18		SUBSTATUS	
19	SEL_MON3/4	SEL_MON3/4	
20		MONITOR3	
21			
22			
23			
24			
25			
26	MONITOR4		
27			
28			
29		EX_STATUS	

7

Data Field

This chapter describes the data field to be used for the main commands and subcommands. Descriptions in this chapter are also contained in the previous chapter describing each command.

The data of each field in the main commands or subcommands is described below.

(1) Status Field Specifications

The status field is used to monitor the SERVOPACK status.
The following table shows the bit allocation in the status field.

D7	D6	D5	D4	D3	D2	D1	D0
PSET/ V_CMP	ZPOINT	—	PON	SVON	CMDRDY	WARNG	ALM

D15	D14	D13	D12	D11	D10	D9	D8
—	—	N_SOT	P_SOT	NEAR/ V_LIM	L_CMP	T_LIM	DEN/ZSPD

The following table explains each bit value and its status.

Bit	Name	Value	Description
D0	ALM	0	No alarm
		1	Alarm occurs.
D1	WARNG	0	No warning
		1	Warning occurs.
D2	CMDRDY	0	Command cannot be received (busy).
		1	Command can be received (ready).
D3	SVON	0	Servo OFF
		1	Servo ON
D4	PON	0	Main power supply OFF
		1	Main power supply ON
D5			
D6	ZPOINT	0	Out of home position range
		1	Within home position range
D7	PSET (During position control)	0	Out of positioning complete range
		1	Within positioning complete range (The output is completed (DEN = 1) and APOS is within the positioning complete range.)
	V_CMP (During speed control)	0	Speed does not coincide.
		1	Speed coincides.
D8	DEN (During position control)	0	During output
		1	Output completed
	ZSPD (During speed control)	0	Zero speed not detected
		1	Zero speed detected
D9	T_LIM	0	Not during torque (force) limit
		1	During torque (force) limit
D10	L_CMP	0	Latch not completed
		1	Latch completed
D11	NEAR (During position control)	0	Out of positioning proximity
		1	Within positioning proximity
	V_LIM (During speed control)	0	Speed limit not detected
		1	Speed limit detected

Bit	Name	Value	Description
D12	P_SOT	0	OT signal is off.
		1	OT signal is on.
D13	N_SOT	0	OT signal is OFF.
		1	OT signal is ON.
D14			
D15			

(2) Monitor Selection and Monitor Information Field Specifications: SEL_MON1/2/3/4, MONITOR 1/2/3/4

The monitor selection (SEL_MON1/2/3/4) field is used to select the Servo monitor information.

- **Applicable Commands:**

SV_ON, SV_OFF, HOLD, INTERPOLATE, POSING, FEED, LATCH, EX_POSING, ZRET, VELCTRL, TRQCTRL, SMON, SENS_ON, SENS_OFF, BRK_ON, BRK_OFF, LTMOD_ON, LTMOD_OFF

- **Setting Method:**

Set MONITOR 1/2/3/4 monitor codes in SEL_MON1/2/3/4 allocated in the thirteenth byte of the main command or in the reserved area of the nineteenth byte of the subcommand.

SEL_MON1/2/3/4 allocation is shown below.

D7	D6	D5	D4	D3	D2	D1	D0
SEL_MON2				SEL_MON1			

D7	D6	D5	D4	D3	D2	D1	D0
SEL_MON4				SEL_MON3			

(3) Monitor Information Field Specifications: MONITOR 1/2/3/4

The monitor information (MONITOR 1/2/3/4) field is used to monitor information selected by the monitor codes in the monitor selection field.

- **Applicable Commands:**

SV_ON, SV_OFF, HOLD, INTERPOLATE, POSING, FEED, LATCH, EX_POSING, ZRET, VELCTRL, TRQCTRL, SMON, SENS_ON, SENS_OFF, BRK_ON, BRK_OFF, LTMOD_ON, LTMOD_OFF

The MONITOR 1/2/3/4 monitor codes are listed below.

Monitor Code	Name	Description	Unit
0	POS	Reference position in reference coordinate system (position after reference filtering)	Reference unit
1	MPOS	Reference position	Reference unit
2	PERR	Position error	Reference unit
3	APOS	Feedback position in machine coordinate system	Reference unit
4	LPOS	Feedback latch position in machine coordinate system	Reference unit
5	IPOS	Reference position in reference coordinate system (position before reference filtering)	Reference unit
6	TPOS	Target position in reference coordinate system	Reference unit
7			
8	FSPD	Feedback speed	Position/torque (force) control: reference units/s Speed control: Maximum speed/4000000H

Monitor Code	Name	Description	Unit
9	CSPD	Reference speed	Position control: Reference units/s Speed control: Maximum speed/ 40000000H
A	TSPD	Target speed	Position control: Reference units/s Speed control: Maximum speed/ 40000000H
B	TRQ	Torque (force) reference (The rated torque is 100%.)	Position/speed control: % (The rated torque is 100%.) Torque (force) control: Maximum torque (force)/40000000H
C			
D			
E	OMN1	Option monitor 1 selected in Pn824	
F	OMN2	Option monitor 2 selected in Pn825	

(4) IO Monitor Field Specifications: IO_MON

The IO monitor field is used to monitor the I/O signal status of the SERVOPACK.

- **Applicable Commands:**

SMON, SV_ON, SV_OFF, HOLD, INTERPOLATE, POSING, ZRET, LATCH, EX_POSING, ZRET, VELCTRL, TRQCTRL, SENS_ON, SENS_OFF, BRK_ON, BRK_OFF, LTMOD_ON, LTMOD_OFF

I/O signal allocation is shown below.

D7	D6	D5	D4	D3	D2	D1	D0
EXT2	EXT1	PC	PB	PA	DEC	N_OT	P_OT

D15	D14	D13	D12	D11	D10	D09	D08
IO15	IO14	IO13	IO12	-	HBB	BRK	EXT3

Bit	Name	Contents	Value	Status
D0	P_OT	Forward run prohibited input	0	OFF
			1	ON
D1	N_OT	Reverse run prohibited input	0	OFF
			1	ON
D2	DEC	Homing deceleration LS input	0	OFF
			1	ON
D3	PA	Encoder phase A input	0	OFF
			1	ON
D4	PB	Encoder phase B input	0	OFF
			1	ON
D5	PC	Encoder phase C input	0	OFF
			1	ON
D6	EXT1	First external latch signal input	0	OFF
			1	ON
D7	EXT2	Second external latch signal input	0	OFF
			1	ON
D8	EXT3	Third external latch signal input	0	OFF
			1	ON

Bit	Name	Contents	Value	Status
D9	BRK	Brake output	0	Released
			1	Locked
D10	HBB	Stop signal input, OR of HWBB1 signal and HWBB2 signal	0	OFF (Forced stop released)
			1	ON (Forced stop)
D11		Reserved	0	
D12	IO12	CN1 input signal selected in Pn81E.0	0	OFF
			1	ON
D13	IO13	CN1 input signal selected in Pn81E.1	0	OFF
			1	ON
D14	IO14	CN1 input signal selected in Pn81E.2	0	OFF
			1	ON
D15	IO15	CN1 input signal selected in Pn81E.3	0	OFF
			1	ON

(5) OPTION Field Specifications

The option field is used to add functions to a motion command.

- **Applicable Commands:**

SV_ON, HOLD, INTERPOLATE, POSING, FEED, LATCH, EX_POSING, ZRET, VELCTRL, TRQCTRL, SVCTRL

Set the functions to be added to a motion command in the main command third and fourth bytes reserved for the option field.

The option field of the Σ -V series SERVOPACK is set by default as shown below.

To change the default setting, set the parameter Pn81F as Pn81F = $\square\square\square 1$, and set the bits to which functions are to be allocated using the parameters Pn82A to Pn82E. The change must be validated by turning the power supply OFF and then ON again or by sending a CONFIG command.

OPTION Field Default Setting.

D7	D6	D5	D4	D3	D2	D1	D0
0	0	0	ACCFIL		0	0	0

D15	D14	D13	D12	D11	D10	D9	D8
N_CL	P_CL	P_PI_CLR	V_PPI	0	0	G_SEL	

- **Functions That Can Be Allocated to Bits of the OPTION Field**

Name	Description	Value	Details	Default Setting
ACCFIL (2 bits)	Acceleration/Deceleration filter	0	No acceleration/deceleration filter	D3, D4
		1	Exponential function acceleration/deceleration	
		2	S-curve acceleration/deceleration	
		3	Do not set.	
G_SEL (2 bits)	Gain switching	0	First gain	D8, D9
		1	Second gain	
		2	Reserved (invalid)	
		3	Reserved (invalid)	

Name	Description	Value	Details	Default Setting	
V_PPI (1 bit)	Speed loop P/PI control	0	PI control	D12	
		1	P control		
P_PI_CLR (1 bit)	Position loop position integral clear	0	Does not clear.	D13	
		1	Clears.		
P_CL (1 bit)	Forward torque (force) limit	0	Does not control torque (force).	D14	
		1	Controls torque (force).		
N_CL (1 bit)	Reverse torque (force) limit	0	Does not control torque (force).	D15	
		1	Controls torque (force).		
LT_DISABLE (1 bit)	Latch signal input disabled	0	Enables latch signal input.	Not allocated	
		1	Disables latch signal input.		
BANK_SEL1 (4 bits)	Bank selector 1 (Bank for acceleration/deceleration parameter switching)	0 to 15	Bank 0 to Bank 15	Not allocated	
OUT_SIGNAL (3 bits)	I/O signal output command	BIT 0	0	SO1 output signal OFF	Not allocated
			1	SO1 output signal ON	
		BIT 1	0	SO2 output signal OFF	
			1	SO2 output signal ON	
		BIT 2	0	SO3 output signal OFF	
			1	SO3 output signal ON	

Note 1. Do not allocate more than one signal to one bit. Otherwise, multiple signals will be controlled by one bit.

2. The bits to which no function is allocated will act as it is set to 0 (zero).

(6) ALM_RD_MOD Specifications

ALM_RD_MOD	Description	Processing Time										
0	Read current alarm/warning status 10 items max. (sixth to fifteenth byte)	Within communications cycle										
1	Read alarm history (warnings and communications alarms A.E50 and A.E60 are not preserved in the history.) 10 records max. (sixth to fifteenth byte)	Within 60 ms										
2	Gets the detailed information of current alarm or warning one by one. Set the occurrence order from 0 (the latest) to 9 for the alarm index.	Within 12 m										
	<table border="1"> <thead> <tr> <th>Byte</th> <th>Command</th> <th>Response</th> </tr> </thead> <tbody> <tr> <td>6</td> <td>Alarm index</td> <td>Alarm index</td> </tr> <tr> <td>7</td> <td>0</td> <td rowspan="2">Alarm code</td> </tr> <tr> <td>8</td> <td>0</td> </tr> </tbody> </table>		Byte	Command	Response	6	Alarm index	Alarm index	7	0	Alarm code	8
Byte	Command	Response										
6	Alarm index	Alarm index										
7	0	Alarm code										
8	0											
3	Gets the detailed information of alarm history one by one. Set the occurrence order from 0 (the latest) to 9 for the alarm index.	Within 12 m										
	<table border="1"> <thead> <tr> <th>Byte</th> <th>Command</th> <th>Response</th> </tr> </thead> <tbody> <tr> <td>6</td> <td>Alarm index</td> <td>Alarm index</td> </tr> <tr> <td>7</td> <td>0</td> <td rowspan="2">Alarm code</td> </tr> <tr> <td>8</td> <td>0</td> </tr> </tbody> </table>		Byte	Command	Response	6	Alarm index	Alarm index	7	0	Alarm code	8
Byte	Command	Response										
6	Alarm index	Alarm index										
7	0	Alarm code										
8	0											

1. When ALM_RD_MOD=0 or 1

An alarm code of 1-byte length is returned.

Example) The communications error alarm A.E61 occurred after warning A.960 occurred.

1) Current warning/alarm (ALM_RD_MOD = 0)

2) Alarm history (ALM_RD_MOD = 1)

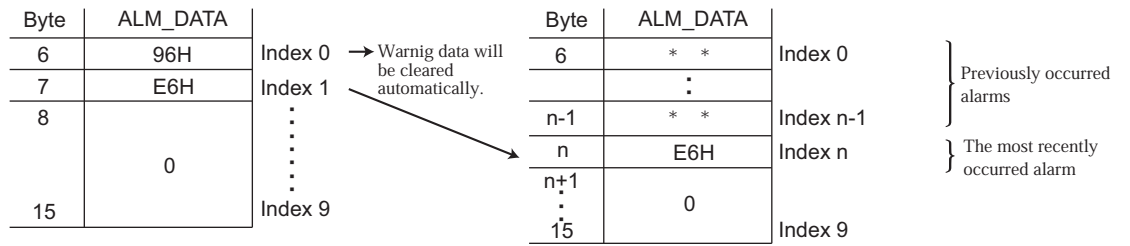

Note 1. The current warning or alarm status can be cleared by executing the ALM_CLR (ALM_CLR_MOD = 0) command.

2. The alarm history will not be cleared until the ALM_CLR(ALM_CLR_MOD = 1) command is executed.

2. When ALM_RD_MOD = 2 or 3

An alarm code of 2-byte length is returned.

If ALM_RD_MOD is set to 2 in the above example, the following alarm codes will be read out.

0x960 for alarm index 0, and

0xE61 for alarm index 1

(7) LT_SGNL Specifications

- Applicable Commands:

LATCH, EX_POSING, ZRET, LTMOD_ON(When Pn850 = 0), SVCTRL

The latch signal can be specified by setting the lowermost two bits of the 2nd byte LT_SGNL in the command as shown below.

D7	D6	D5	D4	D3	D2	D1	D0
0	0	0	0	0	0	LT_SGNL	

D1	D0	Latch Signal	Signal Details
0	0	Phase C	Encoder origin signal
0	1	EXT1	External input signal 1
1	0	EXT2	External input signal 2
1	1	EXT3	External input signal 3

Appendix

A Brake Control Commands	A-2
B General-purpose Servo Control Command	A-4
C Latch Function	A-6

A Brake Control Commands

Command Code	Command	Function
21H	BRK_ON	Turns the brake signal off and applies the holding brake.
22H	BRK_OFF	Turns the brake signal on and releases the holding brake.

(1) Apply Brake (BRK_ON: 21H)

The specifications of BRK_ON (21H) command are described below.

Byte	BRK_ON		Description			
	Command	Response				
1	21H	21H	Phases in which the command can be executed	Phase 2 and 3	Synchronization classification	Asynchronous command
2		ALARM	Processing time	Within communications cycle	Subcommand	Cannot be used
3		STATUS	<p>Turns the brake signal (/BK) off and apply brake. This command is enabled only while the servo is OFF. This command is enabled when the parameter Pn50F.2 is not set to 0. A warning will occur and the command will be ignored in the following cases.</p> <p>If Pn50F.2 = 0: Command warning 3 (A.95C) Brake signal output timing</p>			
4						
5						
6						
7						
8						
9						
10						
11						
12						
13	SEL_MON1/2	SEL_MON1/2				
14		IO_MON				
15						
16	WDT	RWDT				

(2) Release Brake (BRK_OFF: 22H)

The specifications of BRK_OFF command (22H) are described below.

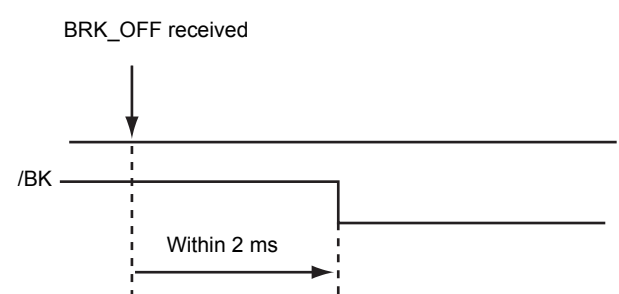
Byte	BRK_OFF		Description
	Command	Response	
1	22H	22H	Phases in which the command can be executed Phase 2 and 3 Synchronization classification Asynchronous command Processing time Within communications cycle Subcommand Cannot be used • Turns the brake signal (/BK) ON and releases the brake. • This command is enabled when Pn50F.2 is not set to 0 • A warning will occur and the command will be ignored in the following cases. - When Pn50F.2 = 0: Command warning 3 (A.95C) • Brake signal output timing 
2		ALARM	
3		STATUS	
4			
5		MONITOR1	
6			
7			
8			
9			
10			
11		MONITOR2	
12			
13	SEL_MON1/2	SEL_MON1/2	
14		IO_MON	
15			
16	WDT	RWDT	



IMPORTANT

BRK_ON and BRK_OFF commands are always valid as command as long as no warning occurs.

Therefore, sending BRK_OFF command while the servomotor is being powered (Servo ON) will not change the operation status.

However, it is very dangerous to send SV_OFF command in the above status since the brake is kept released.

Always make sure of the status of brake control command when using BRK_ON or BRK_OFF command.

B General-purpose Servo Control Command

The specifications of general-purpose servo control command are described below.

Byte	SVCTRL		Description							
	Command	Response								
1	3FH	3FH	Phases in which the command can be executed	Phase 2 and 3	Synchronization classification	Asynchronous command				
2	SUBCTRL	ALARM	Processing time	Depends on processing	Subcommand	Can be used				
3	OPTION	STATUS	<ul style="list-style-type: none"> This command is compatible with MECHATROLINK versions before Ver 1.0. It is used to perform the general-purpose servo control. Latch Processing Supported. Select the latch signal using L_SGN in SUBCTRL and set SET_L to 1. When the selected latch signal is input, L_CMP in STATUS field will become 1. Perform latch processing again after setting SET_L to 0. The latch signal cannot be changed while SET_L = 1. Motion Any of the motions selected for Motion Selection is executed. Sequence Signals Any of the sequence signals listed in the following table is input. 							
4										
5	TOPS	MONITOR1								
6										
7										
8										
9	TSPD/ VFF	MONITOR2								
10										
11										
12										
13	SEL_MON1/2	SEL_MON1/2								
14	SQ_CMD	IO_MON								
15										
16	WDT	RWDT								
17	Subcommand area	Subcommand area								
18										
19										
20										
21										
22										
23										
24										
25										
26										
27										
28										
29										

• Sub-control (SUBCTRL)

D7	D6	D5	D4	D3	D2	D1	D0
RESERVE 0	MOTION Select motion			RESERVE 0	SET_L Latch command	L_SGN Select latch signal	

Select Motion (MOTION)

D6	D5	D4	Motion
0	0	0	HOLD
0	0	1	INTERPOLATE
0	1	0	FEED
0	1	1	POSING

- During phase 1, Command warning 1 (A.95A) will occur for POSING and FEED, and the command will be ignored.
- For INTERPOLATED, in all other phases except phase 3, Command warning 1 (A.95A) will occur and the command will be ignored.

Select Latch Signal (L_SGN)

D1	D0	Latch Signal	Meaning
0	0	Phase C	Encoder zero-point signal
0	1	EXT1	External latch signal 1
1	0	EXT2	External latch signal 2
1	1	EXT3	External latch signal 2

• Sequence Signals: SQ_CMD

D7	D6	D5	D4	D3	D2	D1	D0
Reserved	Reserved	Reserved	Reserved	ACLR Alarm clear	SEN Sensor ON	BRK Brake ON	SON Servo ON

• Applicable Subcommands

CODE	Main Command	Subcommand						
		NOP	PRM_WR	ALM_RD	PPRM_WR	LTMOD_ON	LTMOD_OFF	SMON
3F	SVCTRL	Applicable	Applicable	Applicable	Applicable	Not applicable	Not applicable	Applicable

C Latch Function

Three types of current position latch function using an external signal input are available:

- Latching by using the move command with the latch function (LATCH, EX_POSING, ZRET, SVCTRL)
- Normal latching (one position) by using the LTMOD_ON command
- Continuous latching by using the LTMOD_ON command (Σ -V series new function)

Each type of latching operation is described below.

Operations	Type	Latching by Move Command	Normal (One Position) Latch by LTMOD_ON	Continuous Latch by LTMOD_ON
Latch operation		The slave station starts latching at reception of the command, and completes latching* when the specified latch signal is input.	The slave station starts latching at reception of the command, and completes latching when the specified latch signal is input.	The slave station starts latching at reception of the command, and repeats latching the specified latch signal input position.
Latch operation cancel		Cancelled when the slave station receives another command*	Cancelled by LTMOD_OFF.	
Latch Status monitor		Use STATUS.L_CMP to check the status	Use STATUS.L_CMP to check the status	Use STATUS.L_CMP and EX_STATUS to check the status
Latch Position monitor		The latest signal input position is stored in LPOS.		
Output to MONITOR2 when a latch signal is input		LPOS is forcibly output to MONITOR2 for one communications cycle		
Latching Allowable Area		According to the settings of Pn820 and Pn822		
Operation when a move command with latch function is received during latching			Switched to the operation executed by the move command with latch function. LTMOD_ON/OFF command will become invalid. (Command warning 4 A.95D)	
Operation when LTMOD_ON/OFF command is received during latching		Currently active latching will continue. LTMOD_ON/OFF command is invalid. (Command warning 4 A.95D)		

* For a SVCTRL command, the latch request bit controls latching function.

Revision History

The revision dates and numbers of the revised manuals are given on the bottom of the back cover.

MANUAL NO. SIEPS80000054A

© Printed in Japan July 2007 07-7
└── Date of printing ─┘ └── Date of original publication ─┘

Date of Printing	Rev. No.	WEB Rev. No.	Section	Revised Content
July 2007	–	–	–	First edition

AC Servodrive

Σ -V Series

USER'S MANUAL

MECHATROLINK-II Command

IRUMA BUSINESS CENTER (SOLUTION CENTER)

480, Kamifujisawa, Iruma, Saitama 358-8555, Japan
Phone 81-4-2962-5696 Fax 81-4-2962-6138

YASKAWA ELECTRIC AMERICA, INC.

2121 Norman Drive South, Waukegan, IL 60085, U.S.A.
Phone 1-847-887-7000 Fax 1-847-887-7370

YASKAWA ELÉTRICO DO BRASIL LTDA.

Avenida Fagundes Filho, 620 Bairro Saude-Sao Pãulo-SP, Brazil CEP: 04304-000
Phone 55-11-5071-2552 Fax 55-11-5581-8795

YASKAWA ELECTRIC EUROPE GmbH

Am Kronberger Hang 2, 65824 Schwalbach, Germany
Phone 49-6196-569-300 Fax 49-6196-569-312

YASKAWA ELECTRIC UK LTD.

1 Hunt Hill Orchardton Woods Cumbernauld, G68 9LF, United Kingdom
Phone 44-1236-735000 Fax 44-1236-458182

YASKAWA ELECTRIC KOREA CORPORATION

7F, Doore Bldg. 24, Yeoido-dong, Youngdungpo-Ku, Seoul 150-877, Korea
Phone 82-2-784-7844 Fax 82-2-784-8495

YASKAWA ELECTRIC (SINGAPORE) PTE. LTD.

151 Lorong Chuan, #04-01, New Tech Park 556741, Singapore
Phone 65-6282-3003 Fax 65-6289-3003

YASKAWA ELECTRIC (SHANGHAI) CO., LTD.

No.18 Xizang Zhong Road, Room 1702-1707, Harbour Ring Plaza Shanghai 200001, China
Phone 86-21-5385-2200 Fax 86-21-5385-3299

YASKAWA ELECTRIC (SHANGHAI) CO., LTD. BEIJING OFFICE

Room 1011A, Tower W3 Oriental Plaza, No.1 East Chang An Ave.,
Dong Cheng District, Beijing 100738, China
Phone 86-10-8518-4086 Fax 86-10-8518-4082

YASKAWA ELECTRIC TAIWAN CORPORATION

9F, 16, Nanking E. Rd., Sec. 3, Taipei, Taiwan
Phone 886-2-2502-5003 Fax 886-2-2505-1280



YASKAWA

YASKAWA ELECTRIC CORPORATION

In the event that the end user of this product is to be the military and said product is to be employed in any weapons systems or the manufacture thereof, the export will fall under the relevant regulations as stipulated in the Foreign Exchange and Foreign Trade Regulations. Therefore, be sure to follow all procedures and submit all relevant documentation according to any and all rules, regulations and laws that may apply.

Specifications are subject to change without notice for ongoing product modifications and improvements.

© 2007 YASKAWA ELECTRIC CORPORATION. All rights reserved.

MANUAL NO. SIEP S800000 54A

Printed in Japan July 2007 07-7

07-7①